



STORAGE, TOOL KITS, HANDLING & ACCESS EQUIPMENT

479-491 Storage Chests & Cabinets

492 - 495 BUNKER®

496 Magnetic Holders

497 Contractors Storage Boxes

497-499 Tool Boxes

500 Storage Totes & Trolleys

501-503 Organisers

505-506 Shelving

507-511 Tool Bags, Rolls, Belts & Pouches

512-513 Sack Trucks

514 Trestles

515-516 Workbenches

518-535 Tool Kits

HOW WE MEASURE OUR TOOL BOXES

TOOL BOX DIMENSIONS - The measurements shown in this catalogue are approximate and shown as the following: Length (L), Width (W), and Height (H), and are shown in the information below each catalogue entry.

STEEL TOOL BOXES AND CABINETS - The drawers and storage space are measured showing "internal" dimensions. This provides accurate assessment of the area inside for products - as the steel used to make the metal boxes can be up to 3 or 4mm thick.

PLASTIC TOOL BOXES, STEEL STORAGE CABINETS AND TOOL CASES - These are measured showing the "external" dimension. Generally these are made from thinner materials and the internal measurement is not as critical.

NB: All dimensions can vary during production.



STORAGE CHESTS & CABINETS

Pages **478-491**



CONTRACTORS STORAGE BOXES

Pages **497**



TOOL BOXES

Pages **497-499**



STORAGE TOTES AND TROLLIES

Pages **500**



ORGANISERS

Pages **501-503**



TRESTLES

Pages **514**



BUNKER®

Pages **492-495**



SHELVING

Pages **505-506**



WORKBENCHES

Pages **515-516**



TOOL BAGS, ROLLS, BELTS & POUCHES

Pages **507-511**



SACK TRUCKS

Page **512-513**



TOOL KITS

Pages **518-535**





1

Double Garage Workstation

This complete steel storage unit combines two tall cabinets - each with two doors and three fitted shelves, two wall cabinets, two base cabinets with four drawers and a pressed wood worktop. It is styled with a matt black frame and powder-coated finish doors and is fitted with adjustable feet for stability. A fully lockable system is in place for security (six keys provided). Each unit is fully assembled and the workstation is supplied with all the fittings for a simple installation. This is a complete storage solution (individual components are not available separately).

Contents:

1 x Double Garage Workstation

Stock No.	Part No.
40086	MS200



2

Single Garage Workstation

This complete steel storage unit combines one tall cabinet with four doors and three fitted shelves, two wall cabinets, a base cabinet with four drawers and a pressed wood worktop. There are also two back panels for holding tools and equipment. It is styled with a matt black painted finish and is fitted with adjustable feet for stability. A fully lockable system is in place for security (six keys provided). The workstation is supplied semi-flat packed and requires assembly. This is a complete storage solution (individual components are not available separately).

Contents:

1 x Single Garage Workstation

Stock No.	Part No.
44009	MS100





1
26" Combined Roller Cabinet and Tool Chest (10 Drawers)

Expert Quality, ten drawer metallic silver combined roller cabinet and tool chest. Attached with braked and swivelling castors and soft grip pulling handles for easy manoeuvrability. The reinforced lid is fitted with supportive gas struts and a cable access hole. Manufactured from thick sheet steel with a protective powder coated finish. Drawers are fitted with Aluminium trim, 3mm EVA foam linings, secure locking system with two keys and auto retention ball bearing runners delivering smoother operation. Each tool cabinet is also Supplied with an EVA top mat. Carton packed on a pallet.

Stock No.	Part No.	Dimensions
70501	DTKTC4C/RC6C/G	724 x 458 x 1501mm



2
36" Combined Roller Cabinet and Tool Chest (9 Drawers)

Expert Quality, nine drawers metallic silver combined roller cabinet and tool chest. Attached with braked and swivelling castors and soft grip pulling handles for easy manoeuvrability. The reinforced lid is fitted with supportive gas struts and a cable access hole. Manufactured from thick sheet steel with a protective powder coated finish. Drawers are fitted with Aluminium trim, 3mm EVA foam linings, secure locking system with two keys and auto retention ball bearing runners delivering smoother operation. Each tool cabinet is also Supplied with an EVA top mat. Carton packed on a pallet.

Stock No.	Part No.	Dimensions
70503	DTKTC4C/RC5C	915 x 458 x 473mm



1

52" Combination Roller Cabinet and Tool Chest (13 Drawers)

Expert Quality, thirteen drawers metallic silver combined roller cabinet and tool chest. Attached with braked and swivelling castors and soft grip pulling handles for easy manoeuvrability. The reinforced lid is fitted with supportive gas struts and a cable access hole. Manufactured from thick sheet steel with a protective powder coated finish. Drawers are fitted with Aluminium trim, 3mm EVA foam linings, secure locking system with two keys and auto retention ball bearing runners delivering smoother operation. Each tool cabinet is also Supplied with an EVA top mat. Carton packed on a pallet.

Stock No.	Part No.	Dimensions
70507	DTKTC8C/RC5C	1310 x 458 x 1552mm

2

72" Combined Roller Cabinet and tool chest (25 Drawers)

Expert Quality, twenty-five drawer combined tool chest and cabinet. Manufactured from thick sheet steel with a protective powder-coated finish. Drawers are fitted with aluminium trim, 2mm EVA foam linings, heavy-duty auto retention ball bearing runners delivering a smoother operation and a secure locking system supplied with two keys. The reinforced lid is fitted with supportive gas struts and the six swivel castors, four fitted with a brake and knurled handle deliver greater manoeuvrability.

Contents:

Tool Chest and Roller Cabinet overall size:
W 1830 x D 458 x H 1548mm (including castors)

Weight: 245kg

Tool Chest

Drawer Configuration:

8x W 368.5 x D 406.8 x H 51.2mm

4x W 546 x D 406.8 x H 61.2mm

Overall size:

W 1830 x D 458 x H 524mm

Roller Cabinet

Drawer Configuration:

1 left x W 374.5 x D 375 x H 51.1mm

1 top x W 1242.5 x D 383 x H 101mm

2 right x W 368.5 x D 383 x H 39mm

3 right x W 368.5 x D 383 x H 67mm

1 right x W 368.5 x D 383 x H 191mm

2 middle x W 804.5 x D 383 x H 39mm

1 middle x W 804.5 x D 383 x H 67mm

1 middle x W 804.5 x D 383 x H 151mm

1 middle x W 804.5 x D 383 x H 191mm

Overall size:

W 1830 x D 458 x H 1024mm

Stock No.	Part No.
99401	DTKTC12C/RC13





1 56" Tool Chest (5 Drawer)

Expert Quality, five drawer top tool chest. Manufactured from thick sheet steel with a protective powder coated finish. Drawers are fitted with an Aluminium trim, 3mm EVA foam linings, heavy duty auto retention ball bearing runners delivering a smoother operation and a secure locking system. Each tool chest is also Supplied with a 6mm EVA top mat. Carton packed on pallet.

Contents:

Configuration: 2 x drawers: 398 x 458 x 50mm • 1 x drawer: 398 x 458 x 104mm
2 x drawers: 865 x 458 x 104mm • Overall size: 1410 x 500 x 580mm • Weight: 74kg

Stock No.	Part No.	Dimensions
14585	TC5C/56C	1410 x 500 x 580mm

2 56" Roller Tool Cabinet (11 Drawer)

Expert Quality, eleven drawer professional roller cabinet, fitted with fixed and braked swivelling castors and soft grip pulling handles for easy manoeuvrability. Manufactured from thick sheet steel with a protective powder coated finish. Drawers are fitted with an Aluminium trim, 3mm EVA foam linings, heavy duty auto retention ball bearing runners delivering a smoother operation and a secure locking system. Supplied with two keys. Each tool cabinet is also Supplied with a 10mm EVA top mat. Carton packed on pallet.

Contents:

Configuration: 1 x Full width drawer: 1323 x 458 x 131mm • 1 x drawer: 398 x 458 x 77mm • 2x drawer: 398 x 458 x 131mm • 1x drawer: 398 x 458 x 298mm • 3 x drawer: 873 x 458 x 77mm • 2x drawer: 873 x 458 x 104mm • 1 x drawer: 873 x 458 x 190mm • Overall size: 1422 x 510 x 1130mm

Stock No.	Part No.	Dimensions
14586	RC11C/56C	1422 x 510 x 1130mm



3 56" Roller Tool Cabinet and Tool Chest (16 Drawer)

Expert Quality, sixteen drawer, professional combined roller cabinet and tool chest. Attached with spring loaded suspension fixed to braked and swivelling castors and soft grip pulling handles for easy manoeuvrability. The reinforced lid is fitted with supportive gas struts and two soft grip handles. Manufactured from thick sheet steel with a protective powder coated finish. Drawers are fitted with an Aluminium trim, 3mm EVA foam linings, heavy duty auto retention ball bearing runners delivering a smoother operation and a secure locking system with two keys. Each tool cabinet is also Supplied with a EVA top mat. Carton packed on pallet.

Contents:

Configuration: 3 x drawer: 873 x 458 x 77mm • 2 x drawer: 398 x 458 x 131mm
2 x drawers: 398 x 458 x 50mm • 2 x drawer: 873 x 458 x 104mm • 2 x drawers: 865 x 458 x 104mm • 1 x Full width drawer: 1323 x 458 x 131mm • 1 x drawer: 873 x 458 x 190mm • 1 x drawer: 398 x 458 x 298mm • 1 x drawer: 398 x 458 x 104mm • 1 x drawer: 398 x 458 x 77mm • Overall size: 1422 x 510 x 1690mm • Weight: 231kg

Stock No.	Part No.	Dimensions
11402	DTKTC5C/RC11C	1422 x 510 x 1690mm



FEATURES OF 56" CABINETS AND TOOL CHESTS



Supplied with two keys



Fitted with heavy-duty ball bearing runners



Castors fitted with shock absorbers



Lid fitted with pneumatic struts



Aluminium drawer trim



1 42" Combined Roller Cabinet and Tool Chest (13 Drawer)

Expert Quality, thirteen drawer, professional combined roller cabinet and tool chest. Attached with braked and swivelling castors and soft grip handles for easy manoeuvrability. The reinforced lid is fitted with supportive gas struts and two soft grip handles. Manufactured from thick sheet steel with a protective powder coated finish. Drawers are fitted with an Aluminium trim, 3mm EVA foam linings, heavy duty auto retention ball bearing runners delivering a smoother operation and a secure locking system with two keys. Each tool cabinet is also Supplied with a 6mm EVA top mat. Carton packed on pallet.

Contents:

Configuration: 3 x drawers: 591 x 408 x 77mm • 2 x drawers: 583 x 408 x 77mm • 2 x drawers: 583 x 408 x 50mm • 2 x drawers: 352 x 408 x 50mm • 1 x Full width drawer: 986 x 408 x 131mm • 1 x drawers: 591 x 408 x 320mm • 1 x drawer: 591 x 408 x 104mm • 1 x drawer: 352 x 408 x 158mm • 1 x Pull out locker with internal storage
Overall size: 1067 x 460 x 1725mm • Weight: 172kg

Stock No.	Part No.	Dimensions
11505	DTKTC7C/RC6LC	1067 x 460 x 1725mm



2 42" Tool Chest (4 Drawer)

Expert Quality, four drawer top tool chest. Manufactured from thick sheet steel with a protective powder coated finish. Drawers are fitted with an Aluminium trim, 3mm EVA foam linings, heavy duty auto retention ball bearing runners delivering a smoother operation and a secure locking system Supplied with two keys. The reinforced lid is fitted with supportive gas struts and two soft grip handles. Each tool chest is also Supplied with a 6mm EVA top mat. Carton packed on pallet.

Contents:

Configuration: 2 x drawers: 978 x 408 x 50mm • 2 x drawer: 978 x 408 x 77mm
Overall size: 1055 x 450 x 626mm • Weight: 66kg

Stock No.	Part No.	Dimensions
14494	TC4C/42C	1055 x 450 x 626mm



3 42" Tool Chest With Side Locker (4 Drawers)

Expert Quality, four drawer roller cabinet, fitted with fixed and braked swivelling castors and soft grip handles for easy manoeuvrability. Manufactured from thick sheet steel with a protective powder coated finish. Drawers are fitted with an Aluminium trim, 3mm EVA foam linings, heavy duty auto retention ball bearing runners delivering a smoother operation and a secure locking system Supplied with two keys. Each tool cabinet is also Supplied with a 6mm EVA top mat. Carton packed on pallet.

Contents:

Drawer Configuration: 2x W 583 x D 408 x H 50mm • 2x W 583 x D 408 x H 77mm
Overall size: W 1055 x D 450 x H 626mm

Stock No.	Part No.	Dimensions
14527	TC4LC/42C	1055 x 450 x 626mm



4 26" Tool Chest (9 Drawer)

Expert Quality, nine drawer top tool chest. Manufactured from thick sheet steel with a protective powder coated finish. Drawers are fitted with an Aluminium trim, 3mm EVA foam linings, heavy duty auto retention ball bearing runners delivering a smoother operation and a secure locking system Supplied with two keys. The reinforced lid is fitted with supportive gas struts, a plastic document holder and two soft grip handles. Each tool chest is also Supplied with a 6mm EVA top mat. Carton packed on pallet.

Contents:

Configuration: 3 x Full width drawers: 583 x 408 x 50mm • 6 x Half width drawers: 191 x 408 x 50mm • Overall size: 660 x 450 x 626mm • Weight: 42kg

Stock No.	Part No.	Dimensions
14217	TC9CC	660 x 450 x 626mm

1

40" Tool Chest (8 Drawer)

8 drawer tool chest manufactured from sheet steel with a powder coated finish and Aluminium effect trim. Drawers fitted with ball bearing runners for smoother operation. Each tool chest is fitted with heavy - duty carry handles and a secure integral locking system Supplied with two keys.

Contents:

Configuration: 3 drawers: 570 x 370 x 74.5mm • 3 drawers: 313 x 370 x 74.5mm
1 drawers: 570 x 370 x 153.5mm • 1 drawers: 313 x 370 x 153.5mm

Stock No.	Part No.	Dimensions
15123	TC8D/40	1051 x 405 x 552mm



2

40" Roller Cabinet (11 Drawer)

11 drawer roller cabinet with pulling handle manufactured from sheet steel with a powder coated finish. Fitted with two fixed and two braked, heavy - duty swivelling castors. Drawers are fitted with ball bearing runners for smoother operation and a protective foam liner. Each roller cabinet is fitted with a secure integral locking system Supplied with two keys. Carton packed.

Contents:

Configuration: 3 x drawers: 570 x 410 x 74.5mm • 3 x drawers: 313 x 410 x 74.5mm
• 2 x drawers: 570 x 410 x 153.5mm • 2 x drawers: 313 x 410 x 153.5mm •
1 x drawer: 937 x 410 x 122.5mm

Stock No.	Part No.	Dimensions
15222	RC11D/40	1067 x 458 x 1002mm



3

40" Combined Roller Cabinet and Tool Chest (19 Drawer)

Nineteen drawer combined roller cabinet and tool chest. Attached with two fixed and two braked, heavy - duty swivelling castors a pulling handle and carry handles. Manufactured from sheet steel with a powder coated finish. Drawers are fitted with ball bearing runners for smoother operation and a protective foam liner. Each roller cabinet is fitted with a secure integral locking system Supplied with two keys. Carton packed.

Contents:

Configuration: 3 x drawers: 570 x 410 x 74.5mm • 3 x drawers: 570 x 370 x 74.5mm • 3 x drawers: 313 x 410 x 74.5mm • 3 x drawers: 313 x 370 x 74.5mm
• 2 x drawers: 570 x 410 x 153.5mm • 2 x drawers: 313 x 410 x 153.5mm •
1 x drawer: 937 x 410 x 122.5mm • 1 x drawers: 570 x 370 x 153.5mm •
1 x drawers: 313 x 370 x 153.5mm • Overall size - 672 x 460 x 1554mm

Stock No.	Part No.	Dimensions
17764	DTKTC8D/RC11D	1067 x 458 x 1554mm

FEATURES OF 40" ROLLER CABINETS AND TOOL CHESTS

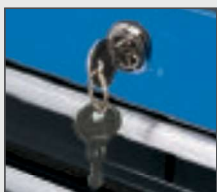

Supplied with two keys



Drawers fitted with ball bearing runners



Rubber castors

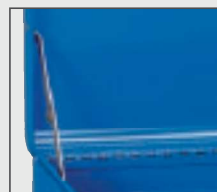

Hinged lid



Aluminium drawer trim



1
26" Tool Chest (4 Drawer)

4 drawer tool chest manufactured from sheet steel with a powder coated finish and Aluminium effect trim. Drawers are fitted with ball bearing runners for smoother operation and a protective foam liner. Each tool chest is fitted with heavy - duty carry handles and a secure integral locking system. Supplied with two keys. Carton packed.

Contents:

Configuration:
3 x drawers: 570 x 273 x 48mm
1 x drawer: 570 x 274 x 74.5mm

Stock No.	Part No.	Dimensions
14589	TC4D	660 x 307 x 377mm



2
26" Tool Chest (5 Drawer)

5 drawer tool chest manufactured from sheet steel with a powder coated finish and Aluminium effect trim. Drawers are fitted with ball bearing runners for smoother operation and a protective foam liner. Each tool chest is fitted with heavy - duty carry handles and a secure integral locking system. Supplied with two keys. Carton packed.

Contents:

Configuration:
4 x drawers: 570 x 273 x 48mm
1 x drawer: 570 x 274 x 74.5mm

Stock No.	Part No.	Dimensions
14604	TC5D	660 x 307 x 435mm



3
26" Tool Chest (6 Drawer)

6 drawer tool chest manufactured from sheet steel with a powder coated finish and Aluminium effect trim. Drawers are fitted with ball bearing runners for smoother operation and a protective foam liner. Each tool chest is fitted with heavy - duty carry handles and a secure integral locking system. Supplied with two keys. Carton packed.

Contents:

Configuration:
3 x drawers: 170.5 x 273 x 48mm
2 x drawers: 570 x 273 x 48mm
1 x drawer: 570 x 273 x 74.5mm

Stock No.	Part No.	Dimensions
14606	TC6D	660 x 307 x 377mm



4
26" Tool Chest (8 Drawer)

8 drawer tool chest manufactured from sheet steel with a powder coated finish and Aluminium effect trim. Drawers are fitted with ball bearing runners for smoother operation and a protective foam liner. Each tool chest is fitted with heavy - duty carry handles and a secure integral locking system. Supplied with two keys. Carton packed.

Contents:

Configuration:
6 x drawers: 170 x 273 x 48mm
1 x drawer: 570 x 273 x 48mm
1 x drawer: 570 x 273 x 74.5mm

Stock No.	Part No.	Dimensions
14898	TC8D	660 x 307 x 377mm



5
26" Tool Chest (9 Drawer)

9 drawer tool chest manufactured from sheet steel with a powder coated finish and Aluminium effect trim. Drawers are fitted with ball bearing runners for smoother operation and a protective foam liner. Each tool chest is fitted with heavy - duty carry handles and a secure integral locking system. Supplied with two keys. Carton packed.

Contents:

Configuration:
6 drawers: 170 x 273 x 48mm
2 drawers: 570 x 273 x 48mm
1 drawer: 570 x 273 x 74.5mm

Stock No.	Part No.	Dimensions
14910	TC9DA	660 x 307 x 435mm



6
26" Tool Chest (10 Drawers)

10 drawer tool chest manufactured from sheet steel with a powder coated finish and Aluminium effect trim. Drawers are fitted with ball bearing runners for smoother operation and a protective foam liner. Each tool chest is fitted with heavy - duty carry handles and a secure integral locking system. Supplied with two keys. Carton packed.

Contents:

Tool Chest
Drawer Configuration:
6 x W 171 x D 410 x H 48mm
2 x W 570 x D 410 x H 48mm
1 x W 171 x D 410 x H 155mm
1 x W 570 x D 410 x H 74mm

Stock No.	Part No.	Dimensions
14937	TC10D	660 x 445 x 488mm



1
26" Intermediate Tool Chest (2 Drawer)

2 drawer intermediate tool chest manufactured from sheet steel with a powder coated finish and Aluminium effect trim. Drawers are fitted with ball bearing runners for smoother operation and a protective foam liner. Each tool chest is fitted with heavy - duty carry handles and a secure integral locking system. Supplied with two keys. Carton packed.

Contents:
Configuration:
1 x Drawers: 570 x 273 x 74.5mm
1 x Drawer: 570 x 273 x 100.5mm

Stock No.	Part No.	Dimensions
14958	TIC2D	670 x 315 x 265mm



2
26" Intermediate Tool Chest (3 Drawers)

3 drawer intermediate tool chest manufactured from sheet steel with a powder coated finish and Aluminium effect trim. Drawers are fitted with ball bearing runners for smoother operation and a protective foam liner. Each tool chest is fitted with heavy - duty carry handles and a secure integral locking system. Supplied with two keys. Carton packed.

Contents:
Drawer Configuration:
2x W 570 x D 410 x H 48mm
1x W 570 x D 410 x H 74mm
Overall size:
W 670 x D 451 x H 265mm

Stock No.	Part No.	Dimensions
14970	TIC3D	670 x 451 x 265mm



3
26" Roller Cabinet (5 Drawer)

5 drawer roller cabinet with pulling handle manufactured from sheet steel with a powder coated finish. Fitted with two fixed and two braked, heavy - duty swivelling castors. Drawers are fitted with ball bearing runners for smoother operation and a protective foam liner. Each roller cabinet is fitted with a secure integral locking system. Supplied with two keys. Carton packed.

Contents:
Configuration:
3 x drawers: 570 x 410 x 74.5mm
2 x drawers: 570 x 410 x 153.5mm

Stock No.	Part No.	Dimensions
14978	RC5D	680 x 458 x 772mm



4
26" Roller Cabinet (7 Drawers)

7 drawer roller cabinet with pulling handle manufactured from sheet steel with a powder coated finish. Fitted with two fixed and two braked, heavy - duty swivelling castors. Drawers are fitted with ball bearing runners for smoother operation and a protective foam liner. Each roller cabinet is fitted with a secure integral locking system. Supplied with two keys. Carton packed.

Contents:
Drawer Configuration:
1x W 570 x D 410 x H 48mm
3x W 570 x D 410 x H 74.5mm
2x W 572 x D 408 x H 100.5mm
1x W 570 x D 410 x H 153.5mm
Overall size:
W 680 x D 458 x H 945mm

Stock No.	Part No.	Dimensions
15040	RC7D	680 x 458 x 945mm



5
26" Roller Cabinet (9 Drawers)

9 drawer roller cabinet with pulling handle manufactured from sheet steel with a powder coated finish. Fitted with two fixed and two braked, heavy - duty swivelling castors. Drawers are fitted with ball bearing runners for smoother operation and a protective foam liner. Each roller cabinet is fitted with a secure integral locking system. Supplied with two keys. Carton packed.

Contents:
Drawer Configuration:
5x W 570 x D 410 x H 48.5mm
3x W 570 x D 410 x H 74.5mm
1x W 570 x D 410 x H 153.5mm
Overall size:
W 672 x D 460 x H 1084mm

Stock No.	Part No.	Dimensions
15110	RC9D	680 x 458 x 945mm



1 26" Combination Roller Cabinet and Tool Chest (15 Drawer)

Fifteen drawer combined roller cabinet and tool chest. Attached with braked and swivelling castors and pulling handles for easy manoeuvrability. Manufactured from sheet steel with a protective powder coated finish. Drawers are fitted with ball bearing runners delivering a smooth operation and a secure locking system with two keys. Carton packed on pallet.

Contents:

Configuration: 5 x Drawers: 570 x 410 x 48.5mm • 3 x Drawers: 570 x 410 x 74.5mm • 3 x Drawers: 170.5 x 273 x 48mm • 2 x Drawers: 570 x 273 x 48mm • 1 x Drawers: 570 x 410 x 153.5mm • 1 x Drawers: 570 x 273 x 74.5mm • Overall size - 680 x 458 x 1322mm

Stock No.	Part No.	Dimensions
11533	RC9D/TC6D	680 x 458 x 1322mm



2 26" Combination Roller Cabinet and Tool Chest (16 Drawer)

Sixteen drawer combined roller cabinet and tool chest. Attached with braked and swivelling castors and pulling handles for easy manoeuvrability. Manufactured from sheet steel with a protective powder coated finish. Drawers are fitted with ball bearing runners delivering a smooth operation and a secure locking system with two keys. Carton packed on pallet.

Contents:

Configuration: 3 x Drawers: 570 x 410 x 74.5mm • 3 x Drawers: 170.5 x 273 x 48mm • 2 x Drawers: 570 x 410 x 48mm • 2 x Drawers: 570 x 273 x 48mm • 1 x Drawers: 570 x 410 x 153.5mm • 1 x Drawers: 570 x 410 x 48mm • 1 x Drawers: 570 x 410 x 74.5mm • 1 x Drawers: 570 x 273 x 74.5mm • Overall size - 680 x 458 x 1414mm

Stock No.	Part No.	Dimensions
11541	TC6D/TIC3D/RC7D	680 x 458 x 1414mm



3 6 Drawer Narrow Pattern Tool Chest

Manufactured from sheet steel with painted finish. Drawers are fitted with ball bearing runners for smooth operation and long life. Narrow pattern for stacking on roller cabinets. Locking systems Supplied with two keys. Carton packed.

Contents:

Configuration: 3 x third width drawers: 150 x 225 x 40mm • 2 x full width drawers: 510 x 225 x 40mm • 1 x full width drawer: 510 x 225 x 80mm

Stock No.	Part No.	Dimensions
51690	TC6B	600 x 255 x 345mm



4 Combined Roller Cabinet and Tool Chest

Two-drawer roller cabinet with large lower storage space and six-multi sized drawer top tool chest, both manufactured from sheet steel with protective paint finish. Roller cabinet is fitted with swivel castors and heavy duty handles. All drawers have built-in ball bearing runners for smoother operation and longer life. Integral locking mechanism on the top chest with two keys supplied. Carton packed.

Contents:

Combined Roller Cabinet and Tool Chest overall size: W 616 x D 330 x H 1080mm (including castors) • Weight: 30kg Tool Chest • Drawer Configuration: 3x W 150 x D 225 x H 40mm • 2x W 510 x D 225 x H 40mm • 1x W 510 x D 225 x H 80mm • Overall size: W 600 x D 260 x H 340mm • Roller Cabinet Drawer Configuration: 2x W 515 x D 280 x H 85mm • Overall size: W 616 x D 330 x H 740mm

Stock No.	Part No.	Dimensions
51177	RCTC8B	615 x 330 x 1000mm



5 26" Tool Chest (5 Drawers)

5 drawer tool chest manufactured from sheet steel with a powder coated finish and Aluminium effect trim. Drawers are fitted with ball bearing runners for smoother operation and a protective foam liner. Each tool chest is fitted with heavy-duty carry handles and a secure integral locking system Supplied with two keys. Carton packed.

Contents:

Drawer Configuration: 4x W 570 x D 410 x H 48mm • 1x W 570 x D 410 x H 74.5mm • Overall size: W 660 x D 445 x H 430mm

Stock No.	Part No.	Dimensions
35746	TC5D/B	660 x 445 x 430mm



1 26" Combination Roller Cabinet and Tool Chest (15 Drawers)

Fifteen drawer combined roller cabinet and tool chest. Attached with braked and swivelling castors and pulling handle for easy manoeuvrability. Manufactured from sheet steel with a protective powder coated finish. Drawers are fitted with ball bearing runners delivering a smooth operation and a secure locking system with two keys. Carton packed on pallet.

Contents:

Combined Roller Cabinet and Tool Chest overall size: W 877 x D 520 x H 1575mm (including castors) • Weight: 95kg • Tool Chest Drawer Configuration: 4x W 570 x D 410 x H 48mm • 1x W 570 x D 410 x H 74.5mm • Overall size: W 660 x D 445 x H 430mm • Intermediate Tool Chest Drawer Configuration: 2x W 570 x D 410 x H 48mm • 1x W 570 x D 410 x H 74mm • Overall size: W 670 x D 451 x H 265mm • Roller Cabinet Drawer Configuration: 1x W 570 x D 410 x H 48mm • 3x W 570 x D 410 x H 74.5mm • 2x W 572 x D 408 x H 100.5mm • 1x W 570 x D 410 x H 153.5mm • Overall size: W 680 x D 458 x H 945mm

Stock No.	Part No.	Dimensions
04593	DTKCTCB	680 x 458 x 1472mm



2 26" Tool Chest (5 Drawers)

5 drawer tool chest manufactured from sheet steel with a powder coated finish and Aluminium effect trim. Drawers are fitted with ball bearing runners for smoother operation and a protective foam liner. Each tool chest is fitted with heavy-duty carry handles and a secure integral locking system. Supplied with two keys. Carton packed.

Contents:

Drawer Configuration: 4x W 570 x D 410 x H 48mm • 1x W 570 x D 410 x H 74.5mm • Overall size: W 660 x D 445 x H 430mm

Stock No.	Part No.	Dimensions
35737	TC5D/BK	660 x 445 x 430mm



3 26" Intermediate Tool Chest (6 Drawers)

3 drawer intermediate tool chest manufactured from sheet steel with a powder coated finish and Aluminium effect trim. Drawers are fitted with ball bearing runners for smoother operation and a protective foam liner. Each tool chest is fitted with heavy-duty carry handles and a secure integral locking system. Supplied with two keys. Carton packed.

Contents:

Drawer Configuration: 2x W 570 x D 410 x H 48mm • 1x W 570 x D 410 x H 74mm • Overall size: W 670 x D 451 x H 265mm

Stock No.	Part No.	Dimensions
35740	TIC3D/BK	670 x 451 x 265mm



4 26" Roller Cabinet (7 Drawers)

7 drawer roller cabinet with pulling handle manufactured from sheet steel with a powder coated finish. Fitted with two fixed and two braked, heavy-duty swivelling castors. Drawers are fitted with ball bearing runners for smoother operation and a protective foam liner. Each roller cabinet is fitted with a secure integral locking system. Supplied with two keys. Carton packed.

Contents:

Drawer Configuration: 1x W 570 x D 410 x H 48mm • 3x W 570 x D 410 x H 74.5mm • 2x W 572 x D 408 x H 100.5mm • 1x W 570 x D 410 x H 153.5mm • Overall size: W 680 x D 458 x H 945mm

Stock No.	Part No.	Dimensions
35745	RC7D/G	734 x 520 x 945mm

5 Combination Roller Cabinet and Tool Chest, 16 Drawer, Red

This is a combination of three units (roller cabinet, mid-section and top chest) to create a great workshop storage solution, stylishly finished with a red frame and black drawers. Manufactured from sheet steel with a powder-coated finish and aluminium trim effect. The drawers are fitted with ball-bearing sliders to provide smoother operation and a protective foam liner. The roller cabinet has a heavy-duty pull handle and sturdy carry handles plus two braked and two fixed heavy-duty swivel castors: an ideal configuration for easy mobility. Each unit has a secure integral locking system. Supplied with two keys.

Contents:

1 x Combination Roller Cabinet and Tool Chest, 16 Drawer, Red

Stock No.	Part No.	Dimensions
04331	TC6/RC7/TIC	



1

26" Combination Roller Cabinet and Tool Chest (15 Drawers)

Fifteen drawer combined roller cabinet and tool chest. Attached with braked and swivelling castors and pulling handle for easy manoeuvrability. Manufactured from sheet steel with a protective powder coated finish. Drawers are fitted with ball bearing runners delivering a smooth operation and a secure locking system with two keys. Carton packed on pallet.

Contents:

Combined Roller Cabinet and Tool Chest overall size: W 877 x D 520 x H 1575mm (including castors) • Weight: 95kg • Tool Chest Drawer Configuration: 4x W 570 x D 410 x H 48mm • 1x W 570 x D 410 x H 74.5mm • Overall size: W 660 x D 445 x H 430mm • Intermediate Tool Chest Drawer Configuration: 2x W 570 x D 410 x H 48mm • 1x W 570 x D 410 x H 74mm • Overall size: W 670 x D 451 x H 265mm • Roller Cabinet Drawer Configuration: 1x W 570 x D 410 x H 48mm • 3x W 570 x D 410 x H 74.5mm • 2x W 572 x D 408 x H 100.5mm • 1x W 570 x D 410 x H 153.5mm • Overall size: W 680 x D 458 x H 945mm

Stock No.	Part No.	Dimensions
04594	DTKCTCB	680 x 458 x 1472mm



2

26" Tool Chest (5 Drawers)

5 drawer tool chest manufactured from sheet steel with a powder coated finish and Aluminium effect trim. Drawers are fitted with ball bearing runners for smoother operation and a protective foam liner. Each tool chest is fitted with heavy - duty carry handles and a secure integral locking system. Supplied with two keys. Carton packed.

Contents:

Drawer Configuration: 4x W 570 x D 410 x H 48mm • 1x W 570 x D 410 x H 74.5mm • Overall size: W 660 x D 445 x H 430mm

Stock No.	Part No.	Dimensions
35739	TC5D/G	660 x 445 x 430mm



3

26" Intermediate Tool Chest (3 Drawers)

3 drawer intermediate tool chest manufactured from sheet steel with a powder coated finish and Aluminium effect trim. Drawers are fitted with ball bearing runners for smoother operation and a protective foam liner. Each tool chest is fitted with heavy - duty carry handles and a secure integral locking system. Supplied with two keys. Carton packed.

Contents:

Drawer Configuration: 2x W 570 x D 410 x H 48mm • 1x W 570 x D 410 x H 74mm • Overall size: W 670 x D 451 x H 265mm

Stock No.	Part No.	Dimensions
35742	TIC3D/G	670 x 451 x 265mm



4

26" Roller Cabinet (7 Drawers)

7 drawer roller cabinet with pulling handle manufactured from sheet steel with a powder coated finish. Fitted with two fixed and two braked, heavy - duty swivelling castors. Drawers are fitted with ball bearing runners for smoother operation and a protective foam liner. Each roller cabinet is fitted with a secure integral locking system. Supplied with two keys. Carton packed.

Contents:

Drawer Configuration: 1x W 570 x D 410 x H 48mm • 3x W 570 x D 410 x H 74.5mm • 2x W 572 x D 408 x H 100.5mm • 1x W 570 x D 410 x H 153.5mm • Overall size: W 680 x D 458 x H 945mm

Stock No.	Part No.	Dimensions
35743	RC7D/BK	734 x 520 x 945mm

5

26" Combination Roller Cabinet and Tool Chest (15 Drawers)

Fifteen drawer combined roller cabinet and tool chest. Attached with braked and swivelling castors and pulling handle for easy manoeuvrability. Manufactured from sheet steel with a protective powder coated finish. Drawers are fitted with ball bearing runners delivering a smooth operation and a secure locking system with two keys. Carton packed on pallet.

Contents:

Combined Roller Cabinet and Tool Chest overall size: W 877 x D 520 x H 1575mm (including castors) • Weight: 95kg • Tool Chest Drawer Configuration: 4x W 570 x D 410 x H 48mm • 1x W 570 x D 410 x H 74.5mm • Overall size: W 660 x D 445 x H 430mm • Intermediate Tool Chest Drawer Configuration: 2x W 570 x D 410 x H 48mm • 1x W 570 x D 410 x H 74mm • Overall size: W 670 x D 451 x H 265mm • Roller Cabinet Drawer Configuration: 1x W 570 x D 410 x H 48mm • 3x W 570 x D 410 x H 74.5mm • 2x W 572 x D 408 x H 100.5mm • 1x W 570 x D 410 x H 153.5mm • Overall size: W 680 x D 458 x H 945mm

Stock No.	Part No.	Dimensions
04596	DTKCTCG	680 x 458 x 1472mm





1
26" Tool Chest (5 Drawers)

5 drawer tool chest manufactured from sheet steel with a powder coated finish and Aluminium effect trim. Drawers are fitted with ball bearing runners for smoother operation and a protective foam liner. Each tool chest is fitted with heavy - duty carry handles and a secure integral locking system Supplied with two keys. Carton packed.

Contents:

Drawer Configuration: 4x W 570 x D 410 x H 48mm • 1x W 570 x D 410 x H 74.5mm • Overall size: W 660 x D 445 x H 430mm

Stock No.	Part No.	Dimensions
35738	TC5D/W	660 x 445 x 430mm

2
26" Intermediate Tool Chest (3 Drawers)

3 drawer intermediate tool chest manufactured from sheet steel with a powder coated finish and Aluminium effect trim. Drawers are fitted with ball bearing runners for smoother operation and a protective foam liner. Each tool chest is fitted with heavy - duty carry handles and a secure integral locking system Supplied with two keys. Carton packed.

Contents:

Drawer Configuration: 2x W 570 x D 410 x H 48mm • 1x W 570 x D 410 x H 74mm • Overall size: W 670 x D 451 x H 265mm

Stock No.	Part No.	Dimensions
35741	TIC3D/W	670 x 451 x 265mm



3
26" Roller Cabinet (7 Drawers)

7 drawer roller cabinet with pulling handle manufactured from sheet steel with a powder coated finish. Fitted with two fixed and two braked, heavy - duty swivelling castors. Drawers are fitted with ball bearing runners for smoother operation and a protective foam liner. Each roller cabinet is fitted with a secure integral locking system Supplied with two keys. Carton packed.

Contents:

Drawer Configuration: 1x W 570 x D 410 x H 48mm • 3x W 570 x D 410 x H 74.5mm • 2x W 572 x D 408 x H 100.5mm • 1x W 570 x D 410 x H 153.5mm Overall size: W 680 x D 458 x H 945mm

Stock No.	Part No.	Dimensions
35744	RC7D/W	734 x 520 x 945mm



4
26" Combination Roller Cabinet and Tool Chest (15 Drawers)

Fifteen drawer combined roller cabinet and tool chest. Attached with braked and swivelling castors and pulling handle for easy manoeuvrability. Manufactured from sheet steel with a protective powder coated finish. Drawers are fitted with ball bearing runners delivering a smooth operation and a secure locking system with two keys. Carton packed on pallet.

Contents:

Combined Roller Cabinet and Tool Chest overall size: W 877 x D 520 x H 1575mm (including castors) • Weight: 95kg • Tool Chest Drawer Configuration: 4x W 570 x D 410 x H 48mm • 1x W 570 x D 410 x H 74.5mm • Overall size: W 660 x D 445 x H 430mm • Intermediate Tool Chest Drawer Configuration: 2x W 570 x D 410 x H 48mm • 1x W 570 x D 410 x H 74mm • Overall size: W 670 x D 451 x H 265mm • Roller Cabinet Drawer Configuration: • 1x W 570 x D 410 x H 48mm • 3x W 570 x D 410 x H 74.5mm • 2x W 572 x D 408 x H 100.5mm • 1x W 570 x D 410 x H 153.5mm • Overall size: W 680 x D 458 x H 945mm

Stock No.	Part No.	Dimensions
04597	DTKCTCW	680 x 458 x 1472mm





1

2

3

4



1

24" Combined Roller Cabinet and Tool Chest (6 Drawers)

6 drawer roller cabinet and tool chest manufactured from sheet steel with a powder coated finish and Aluminium effect trim. Drawers are fitted with ball bearing runners for smoother operation. Fitted with heavy - duty handles, swivelling castors and a secure integral locking system Supplied with two keys.

Contents:

Combined Roller Cabinet and Tool Chest overall size: W 616 x D 330 x H 998mm (including castors) • Weight: 30kg • Tool Chest Drawer Configuration: 3x W 511 x D 225 x H 40mm • 1x W 511 x D 225 x H 84mm • Overall size: W 600 x D 260 x H 340mm • Roller Cabinet Drawer Configuration: 2x W 511 x D 308 x H 84mm • Overall size: W 616 x D 330 x H 658mm

Stock No.	Part No.	Dimensions
19563	RCTC6/B	616 x 330 x 998mm

2

24" Combined Roller Cabinet and Tool Chest (6 Drawers)

6 drawer roller cabinet and tool chest manufactured from sheet steel with a powder coated finish and Aluminium effect trim. Drawers are fitted with ball bearing runners for smoother operation. Fitted with heavy - duty handles, swivelling castors and a secure integral locking system Supplied with two keys.

Contents:

Combined Roller Cabinet and Tool Chest overall size: W 616 x D 330 x H 998mm (including castors) • Weight: 30kg • Tool Chest Drawer Configuration: 3x W 511 x D 225 x H 40mm • 1x W 511 x D 225 x H 84mm • Overall size: W 600 x D 260 x H 340mm • Roller Cabinet Drawer Configuration: 2x W 511 x D 308 x H 84mm • Overall size: W 616 x D 330 x H 658mm

Stock No.	Part No.	Dimensions
19572	RCTC6/BK	616 x 330 x 998mm

3

24" Combined Roller Cabinet and Tool Chest (6 Drawers)

6 drawer roller cabinet and tool chest manufactured from sheet steel with a powder coated finish and Aluminium effect trim. Drawers are fitted with ball bearing runners for smoother operation. Fitted with heavy - duty handles, swivelling castors and a secure integral locking system Supplied with two keys.

Contents:

Combined Roller Cabinet and Tool Chest overall size: W 616 x D 330 x H 998mm (including castors) • Weight: 30kg • Tool Chest Drawer Configuration: 3x W 511 x D 225 x H 40mm • 1x W 511 x D 225 x H 84mm • Overall size: W 600 x D 260 x H 340mm • Roller Cabinet Drawer Configuration: 2x W 511 x D 308 x H 84mm • Overall size: W 616 x D 330 x H 658mm

Stock No.	Part No.	Dimensions
19566	RCTC6/G	616 x 330 x 998mm

4

24" Combined Roller Cabinet and Tool Chest (6 Drawer)

6 drawer roller cabinet and tool chest manufactured from sheet steel with a powder coated finish and Aluminium effect trim. Drawers are fitted with ball bearing runners for smoother operation. Fitted with heavy - duty handles, swivelling castors and a secure integral locking system Supplied with two keys.

Contents:

Combined Roller Cabinet and Tool Chest overall size: W 616 x D 330 x H 998mm (including castors) • Weight: 30kg • Tool Chest Drawer Configuration: 3x W 511 x D 225 x H 40mm • 1x W 511 x D 225 x H 84mm • Overall size: W 600 x D 260 x H 340mm • Roller Cabinet Drawer Configuration: 2x W 511 x D 308 x H 84mm • Overall size: W 616 x D 330 x H 658mm

Stock No.	Part No.	Dimensions
19576	RCTC6/W	616 x 330 x 998mm

STORAGE THAT MAKES A STATEMENT

Discover BUNKER®. The **NEW** modular range that's all about making the most of your storage. Buy and save when you choose one of four clever combos. Or unleash your creativity and create a totally customised storage solution with the individual units. Build a truly original and distinctive BUNKER®, one piece at a time.

Whatever you choose, look forward to stunning design. Premium steel construction. And meticulous attention to detail, including hardwood or stainless steel work surfaces, incredibly versatile shelving, whisper-quiet gas struts and adjustable feet for uneven ground. All with the added reassurance of a 10-year warranty.

The Definitive BUNKER® Modular Storage Combo 25 Pieces of Perfection

Cool. Convenient. Cost-effective. Cover every option with this fully-featured 25-piece BUNKER® combo.

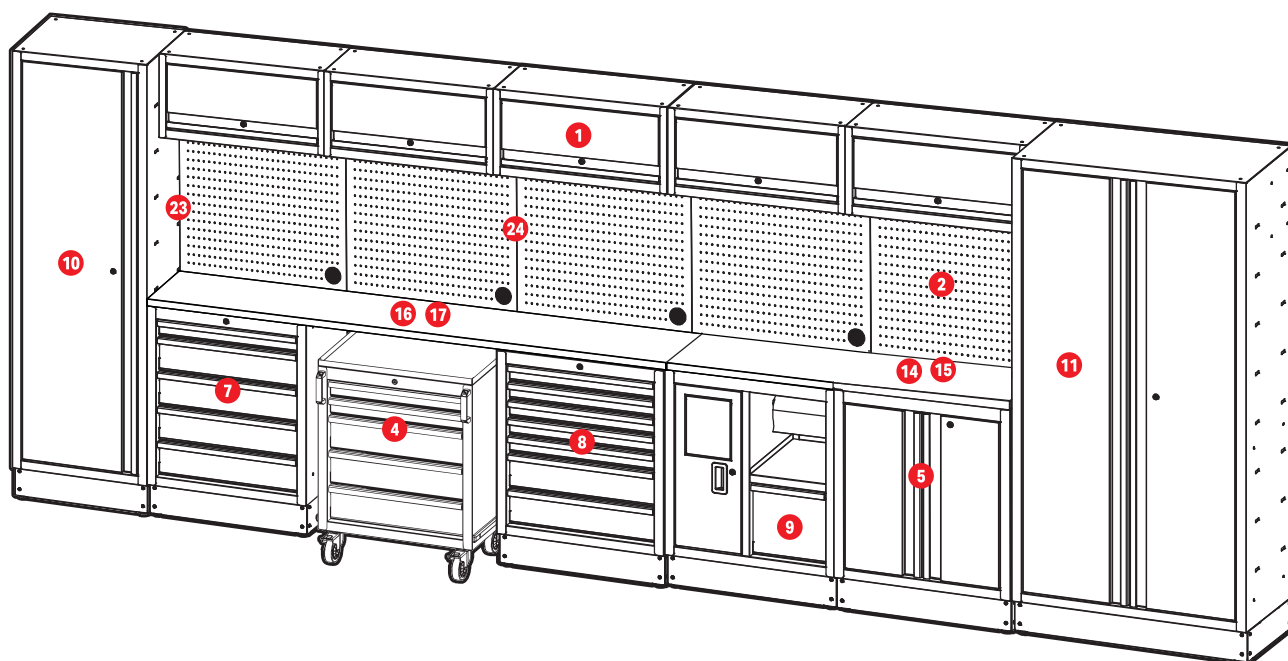

Contents:

1 5 x Wall Cabinets 2 5 x Back Panels 4 1 x 5 Drawer Mobile Cabinet 5 1 x 2 Door Floor Cabinet 7 1 x 5 Drawer Floor Cabinet 8 1 x 7 Drawer Floor Cabinet 9 1 x Multi-Function Floor Cabinet 10 1 x 1 Door Tall Floor Cabinet 11 1 x 2 Door Tall Floor Cabinet 1 x Worktop (14 Steel or 15 Hardwood) and 1 x Worktop (16 Steel or 17 Hardwood) 23 2 x Side Wall Single Brackets 24 4 x Side Wall Double Brackets

6 Sink cabinet also available instead of 5 Sink and basin are stainless steel.

For illustration purposes only. Discuss available options with your retailer.

SEE PAGE 495 FOR INDIVIDUAL UNIT DIMENSIONS.

Made up units	Overall weight (approx.)	Overall dimensions	Free magnets (x2)	Worktops	Stock No.
Combo with Sink and Hardwood Worktop (25 Piece)	465kg	W 4,915 x H 2,000 x D 463mm			04389
Combo with Hardwood Worktop (25 Piece)	471kg				04390
Combo with Sink and Stainless Steel Worktop (25 Piece)	468kg				04391
Combo with Stainless Steel Worktop (25 Piece)	479kg				04393

BUNKER
BY DRAPER TOOLS



*tools not included

BUNKER® Modular Storage Combo (16 Piece)

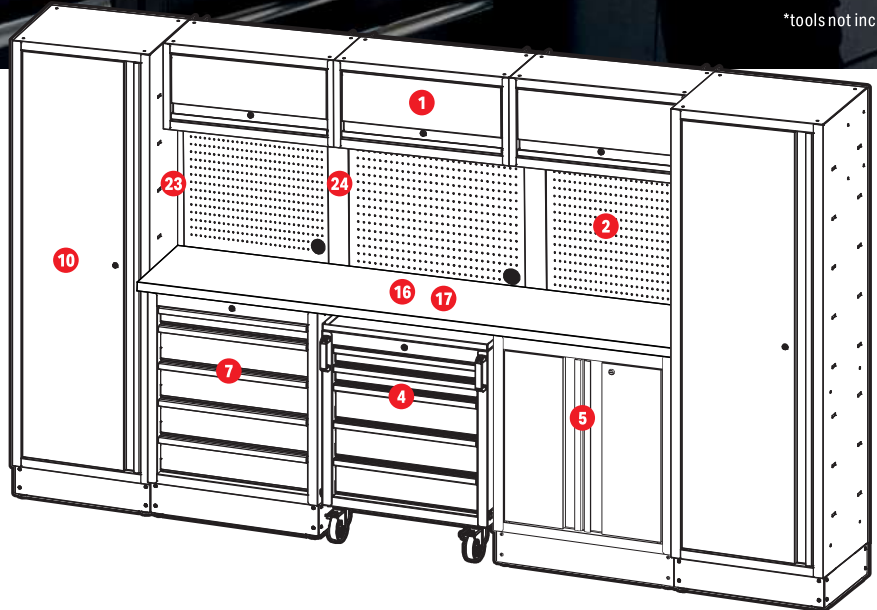



Contents:

- 1 3 x Wall Cabinets 2 3 x Back Panels 4 1 x 5 Drawer Mobile Cabinet 5 1 x 2 Door Floor Cabinet
- 7 1 x 5 Drawer Floor Cabinet 10 2 x 1 Door Tall Floor Cabinets 1 x Worktop (16 Steel or 17 Hardwood)
- 23 2 x Side Wall Single Brackets 24 2 x Side Wall Double Brackets

For illustration purposes only. Discuss available options with your retailer.

**SEE PAGE 495 FOR INDIVIDUAL
UNIT DIMENSIONS.**

Made up units	Overall weight (approx.)	Overall dimensions	Free magnets (x2)	Worktops	Stock No.
Combo with Hardwood Worktop (16 Piece)	315kg	W 3,240 x H 2,000 x D 463mm			04398
Combo with Stainless Steel Worktop (16 Piece)	320kg				04402

BUNKER® Modular Storage Combo (14 Piece)

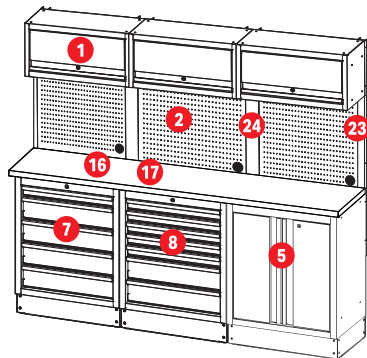

Contents:

- 1 3 x Wall Cabinets 2 3 x Back Panels
- 5 1 x 2 Door Floor Cabinet 7 1 x 5 Drawer Floor Cabinet
- 8 1 x 7 Drawer Floor Cabinet
- 1 x Worktop (16 Steel or 17 Hardwood)
- 23 2 x Side Wall Single Brackets 24 2 x Side Wall Double Brackets



SEE PAGE 495 FOR INDIVIDUAL UNIT DIMENSIONS.

Made up units	Overall weight (approx.)	Overall dimensions	Free magnets (x1)	Worktops	Stock No.
Combo with Hardwood Worktop (14 Piece)	210kg	W 2,040 x H 2,000 x D 463mm			04411
Combo with Stainless Steel Worktop (14 Piece)	215kg				04415

BUNKER® Modular Storage Combo (11 Piece)

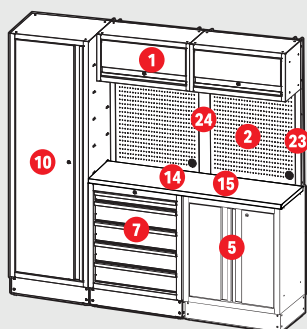

Contents:

- 1 2 x Wall Cabinets 2 2 x Back Panels 5 1 x 2 Door Floor Cabinet
- 7 1 x 5 Drawer Floor Cabinet 10 1 x 1 Door Tall Floor Cabinet
- 1 x Worktop (14 Steel or 15 Hardwood) 23 2 x Side Wall Single Brackets
- 24 1 x Side Wall Double Bracket































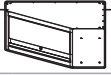

SEE PAGE 495 FOR INDIVIDUAL UNIT DIMENSIONS.

Made up units	Overall weight (approx.)	Overall dimensions	Free magnets (x1)	Worktops	Stock No.
Combo with Hardwood Worktop (11 Piece)	198kg	W 1,960 x H 2,000 x D 463mm			04488
Combo with Stainless Steel Worktop (11 Piece)	202kg				04503

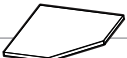
24 INDIVIDUAL UNITS ENDLESS STORAGE POSSIBILITIES

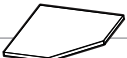
BUNKER®
BY DRAPER TOOLS

Unleash your creativity and create a totally customised storage solution with these individual units, including corner options. Build a truly original and distinctive BUNKER®, one piece at a time.

Storage units		Dimensions	Max. load per drawer/shelf	Stock No.
1	Wall Cabinet	 W 680 x H 350 x D 280 mm	22.7kg	33162
2	Back Panel	 W 602 x H 1,081 x D 24 mm		33196
3	7 Drawer Mobile Cabinet	 W 646 x H 862 x D 458mm	22.7kg	29779
4	5 Drawer Mobile Cabinet	 W 646 x H 862 x D 458mm	22.7kg	29792
5	2 Door Floor Cabinet	 W 680 x H 910 x D 458 mm	36.4kg	30350
6	2 Door Floor Cabinet With Sink (Tap and waste not included)	 W 680 x H 948 x D 463 mm		31034
7	5 Drawer Floor Cabinet	 W 680 x H 910 x D 458 mm	22.7kg	31387
8	7 Drawer Floor Cabinet	 W 680 x H 910 x D 458 mm	22.7kg	31706
9	Multi-Function Floor Cabinet	 W 680 x H 910 x D 458 mm	22.7kg	33161
10	1 Door Tall Floor Cabinet	 W 600 x H 2,000 x D 458 mm	27.3kg	33165
11	2 Door Tall Floor Cabinet	 W 915 x H 2,000 x D 458 mm	36.4kg	33166
Worktops		Dimensions		Stock No.
12	Stainless Steel Worktop	 W 680 x H 38 x D 463 mm		33171
13	Hardwood Worktop	 W 680 x H 38 x D 463 mm		33180
14	Stainless Steel Worktop	 W 1,360 x H 38 x D 463 mm		33172
15	Hardwood Worktop	 W 1,360 x H 38 x D 463 mm		33182
16	Stainless Steel Worktop	 W 2,040 x H 38 x D 463 mm		33178
17	Hardwood Worktop	 W 2,040 x H 38 x D 463 mm		33192
Corner units		Dimensions		Stock No.
18	Corner Wall Cabinet	 W 865 x H 350 x D 860 mm	27.3kg	33201
19	Corner Unit Back Panels (Pair)	 W 795 x H 1,081 x D 24 mm		33212
20	Stainless Steel Worktop For Corner Cabinet	 W 865 x H 38 x D 860 mm		33203
21	Hardwood Worktop For Corner Cabinet	 W 865 x H 38 x D 860 mm		33210
22	Corner Floor Cabinet	 W 865 x H 910 x D 861 mm	45.5kg	33199
Connecting brackets		Dimensions		Stock No.
23	Side Wall Single Bracket	 W 1,420 x H 30 x D 39 mm		33197
24	Side Wall Double Bracket	 W 1,420 x H 30 x D 78 mm		33198



1
Magnetic Cup Holder

Magnetic cup holder, suitable for use with cups, cans, water bottles and aerosol cans. Made from ABS plastic, fitted with a powerful magnet for attaching to tool cabinets, metal storage units or any other ferrous metal surface. Size - 90mm diameter x 120mm.

Stock No.	Part No.
11702	MPTCH



2
Magnetic Holder for Glove/Tissue Boxes

For storage of standard size boxes of latex gloves or tissues up to 145mm wide. Holder has rubber protected magnetic back for affixing to vertical metal objects such as tool boxes etc. Optional hanging holes for fixing in permanent locations. Display packed.

Stock No.	Part No.
78665	MPT13



3
Magnetic Storage Holder

Magnetic holder ideal for storing spray cans and workshop equipment. Capable of holding two aerosol spray cans and five screwdrivers with a combined weight capacity of 0.87kg. Made from powder coated steel fitted with powerful magnets suitable for attaching to tool cabinets, metal storage units or any other ferrous metal surface. Size 100 x 210 x 126mm.

Stock No.	Part No.
11807	MPTSC



4
Magnetic Tool Tray Set (3 Piece)

Magnetic tool tray set, made from powder coated steel fitted with powerful magnets suitable for attaching to tool cabinets, metal storage units or any other ferrous metal surface. Each magnet has a protective cover helping prevent scratching to the metal surfaces. Sizes 150 x 110 x 120mm with a load capacity 0.6kg, 210 x 110 x 120mm with a load capacity 0.77kg, 270 x 110 x 120mm with a load capacity 1.0kg.

Stock No.	Part No.
11755	MPTTS/3



5
Magnetic Hook Set (10 Piece)

Magnetic hook set ideal for holding various items up to a weight of 3.5kg. Made from carbon steel with a powerful magnet for attaching to tool cabinets, metal storage units or any other ferrous metal surface.

Stock No.	Part No.
11960	MPTH/10



6
Magnetic Tool Holder

Magnetic tool holder ideal for and organizing wrenches, sockets, fasteners and workshop equipment. The powerful magnets make it suitable for attaching to tool cabinets, metal storage units or any other ferrous metal surface. Size 300 x 50 x 14mm.

Stock No.	Part No.
11786	MPTTH



7
Magnetic Holder

For attaching to the side of metal objects using powerful magnets. 50mm diameter. Hook and loop straps for holding different sized tools. Display packed.

Stock No.	Part No.
50984	MPT12B



1

Black Box® Contractor's Secure Storage Boxes

Heavy duty contractors storage boxes manufactured from sheet steel with powder coated finish. Ideal for use on site, in vans, workshops or garages. Feet with bolt holes for fixing to a solid base to avoid complete removal. Gas strut and integrated single pin hinge. Heavy duty lifting handles and the raised feet allow for easier movement by fork lift trucks. Two cut outs on front for padlock attachment. Carton packed.

Stock No.	Part No.	Dimensions
05543	DBB915/B	915 x 470 x 590mm
05544	DBB1220/B	1220 x 610 x 700mm



2

Contractor's Secure Storage Boxes

Heavy duty contractors storage boxes manufactured from sheet steel with powder coated finish. Ideal for use on site, in vans, workshops or garages. Feet with bolt holes for fixing to a solid base to avoid complete removal. Gas strut and integrated single pin hinge. Heavy duty lifting handles and the raised feet allow for easier movement by fork lift trucks. Two cut outs on front for padlock attachment. Carton packed.

Stock No.	Part No.	Dimensions
78785	DBB915/B/Y	915 x 470 x 590mm
78787	DBB1220/B/Y	1220 x 610 x 700mm



3

Extra Long Four Tray Cantilever Tool Box, 530mm

Expert Quality, professional's extra long tool box manufactured from heavy gauge sheet steel, tubular handles and powder coated finish. Trays open automatically when handle is depressed and close when lifted. The lid form incorporates provision for a padlock. Carton packed.

Contents:

Overall size: W 530 x D 200 x H 210mm
Weight: 4.99kg

Stock No.	Part No.	Dimensions
88904	TB530	530 x 200 x 210mm

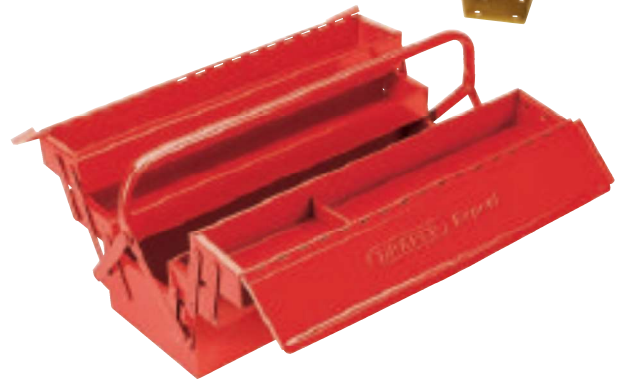

4

Plastic Tool Box with Tote Tray, 580mm

Expert Quality, professional's tool box manufactured from tough durable plastic. Two clip type locks on lid and soft grip carrying handle. Carton packed.

Contents:

Overall size: W 580 x D 265 x H 250mm
Weight: 3.85kg

Stock No.	Part No.	Dimensions
27732	TB580	580 x 265 x 250mm



5

Aluminium Tool Case

Aluminium - effect tool case, complete with pallet in lid and padded dividers. Heavy duty square corners, twin lockable catches and Supplied with two keys. Ideal tool case for engineers, photographers etc. Carton packed with label.

Contents:

Overall size: W 460 x D 330 x H 150mm
Weight: 2.6kg

Stock No.	Part No.	Dimensions
85743	TC9E	460 x 330 x 150mm





1
500mm Heavy Duty Tote Tray

Expert Quality, heavy duty impact resistant polypropylene tote tray with two extra deep compartments size 440 x 95 x 150mm and two smaller size 80 x 80 x 60mm. Pre - drilled holes for storage. Sturdy Aluminium soft grip handle. Sold loose.

Stock No.	Part No.	Dimensions
05179	TT500	500 x 350 x 220mm



2
Mobile Tool Chest

Expert Quality, tool box on heavy duty wheels manufactured from tough durable plastic with integral telescopic transport handle. Supplied with tote tray and tool box lid with strap for holding a spirit level. Bar locking handle secures the lid which has a padlock eye for security. Graduated V groove in lid for cutting wood etc. Carton packed.

Contents:
Configuration:
Tool box (external): 740 x 450 x 490mm
Tool box (internal): 680 x 380 x 380mm
Tote tray (internal): 740 x 450 x 490mm
Overall size: W 740 x D 450 x H 490mm
Weight: 3.85kg

Stock No.	Part No.	Dimensions
22291	TB755	740 x 450 x 490mm



3
2 Drawer Tool Chest/Tool Box

Suitable for the storage of small hand tools. Piano hinged lid and top storage area. Heavy gauge sheet steel with powder coated finish. Drawers fitted with ball bearing runners for smooth operation and EVA foam liners. Secure integral locking system with two keys. Inset handles at both ends. Carton packed.

Contents:
Configuration:
2 x Full width drawers: 365 x 205 x 52mm
1 x Tool storage area: 455 x 230 x 60mm

Stock No.	Part No.	Dimensions
03243	TC2B	460 x 240 x 250mm



4
Barn Type Tool Box with Tote Tray, 485mm

General purpose tool box manufactured from sheet steel with plastic tote tray size 485 x 180 x 170mm. Clip type lock on the lid which also incorporates provision for a padlock. Carton packed.

Stock No.	Part No.	Dimensions
86675	TB484	485 x 180 x 170mm



5
2 Tray Cantilever Tool Box, 404mm

General purpose tool box manufactured from sheet steel with tubular handles and lacquered finish. Trays open automatically when handle is depressed and close when lifted. The lid form incorporates provision for a padlock. Carton packed.

Stock No.	Part No.	Dimensions
86673	TB404B	404 x 200 x 170mm



6
Extra Long Four Tray Cantilever Tool Box, 495mm

General purpose extra long tool box formed from sheet steel with tubular handles and lacquered finish. Trays open independently when handles are pulled apart and the tray lids feature padlock tabs. Carton packed.

Stock No.	Part No.	Dimensions
86671	TB495	495 x 295 x 200mm



7
Barn Type Tool Box with 4 Cantilever Trays, 460mm

General purpose tool box manufactured from sheet steel with lacquered finish. The lid incorporates provision for a padlock. Carton packed.

Stock No.	Part No.	Dimensions
48566	TB459B	460 x 257 x 355mm





1
Tool/Organiser Box with Tote Tray, 320mm

Impact - resistant polypropylene with three storage compartments in lid. Fitted with sturdy carrying handle and plastic latch closure. The removable tote tray measures 300x130x25mm. Sold loose.

Stock No.	Part No.	Dimensions
53875	TB320	320 x 165 x 136mm

2
Tool/Organiser Box with Tote Tray, 410mm

Impact - resistant polypropylene fitted with sturdy carrying handle, two closing latches and a padlock eye for security. The removable tote tray measures 380x170x38mm. Sold loose.

Stock No.	Part No.	Dimensions
53876	TB410	410 x 209 x 195mm

3
Tool/Organiser Box with Tote Tray, 413mm

Impact - resistant polypropylene with three storage compartments in lid. Fitted with sturdy carrying handle, two metal closing latches and a padlock eye for security. The removable tote tray measures 395 x 160 x 35mm. Sold loose.

Stock No.	Part No.	Dimensions
53878	TB413	413 x 212 x 186mm



4
Tool/Organiser Box with Tote Tray, 486mm

Impact - resistant polypropylene with three storage compartments in lid. Fitted with sturdy carrying handle, two metal closing latches and a padlock eye for security. The removable tote tray measures 470 x 200 x 45mm. Sold loose.

Stock No.	Part No.	Dimensions
53880	TB486	486 x 267 x 242mm

5
Large Tool Box with Tote Tray, 564mm

Impact - resistant polypropylene with three storage compartments in lid. Fitted with sturdy carrying handles, two metal closing latches on the front and two side closing latches. Incorporating a heavy duty moulded pad-lock eye which provides space for a padlock. The removable tote tray measures 525x260x48mm. Sold loose.

Stock No.	Part No.	Dimensions
53887	TB564	564 x 310 x 310mm

6
Plastic Cantilever Toolbox, 454mm

Innovative design made from robust moulded plastic. Fitted with heavy duty metal cantilever hinges and plastic catches. Storage compartments facilitate flexible storage solutions by using the 18 removable dividers. Fitted with a padlock hole for added security. Carton packed.

Contents:
Overall size: W 454 x D 235 x H 235mm
Weight: 2.14kg

Stock No.	Part No.	Dimensions
14709	TBCL454	454 x 235 x 235mm





1
Tool Storage Tote Tray, 340 x 240 x 130mm

Impact-resistant polypropylene with three compartments for the storage of tools etc. Sold loose.

Stock No.	Part No.	Dimensions
54925	TT2C	340 x 240 x 130mm



2
Storage Tote, 450 x 350 x 255mm

Manufactured from ABS plastic. The 28L capacity is ideal for use around the house, office, workshop, garage or vehicle. Sold loose.

Stock No.	Part No.	Dimensions
64058	SSB5	450 x 350 x 255mm



3
2 Tier Tool Trolley

Mobile workshop trolley ideal for moving bulky heavy equipment. Manufactured from heavy duty 0.6mm steel with a powder coated protective finish. Fitted with two swivelling castors and two fixed. Carton packed .

Stock No.	Part No.	Dimensions
07629	TTB2	845 x 410 x 780mm



4
3 Tier Tool Trolley

Mobile workshop trolley ideal for moving bulky heavy equipment. Manufactured from heavy duty 0.6mm steel with a powder coated protective finish. Fitted with two swivelling castors and two fixed. Carton packed .

Stock No.	Part No.	Dimensions
07630	TTB3	845 x 410 x 780mm



5
2 Tier Tool Trolley with Two Drawers

Expert Quality, mobile workshop trolley with two full width lockable drawers on ball bearing runners for smooth operation. Manufactured from heavy duty steel with a powder coated protective finish. Fitted with handle and four castors (two fixed and two swivelling). Secure integral locking system Supplied with two keys. Carton packed .

Stock No.	Part No.	Dimensions
07635	TT2DB	712 x 440 x 694mm



6
3 Tier Workshop Trolley

Plastic shelves with Aluminium uprights, comprising three shelves each with three compartments with removable dividers, six screwdriver holding slots, four additional compartments, two cup holders and a cable tidy. Two fixed and two lockable swivelling castor wheels. Supplied flat packed with instruction booklet. Carton packed.

Contents:

Configuration:
each tier: 2 compartments: 120 x 260 x 40mm, 1 compartment: 220 x 260 x 40mm

Stock No.	Part No.	Dimensions
04612	WST-2	570 x 450 x 890mm



1 4 to 21 Compartment Plastic Organiser

Plastic organiser with an adjustable matrix of storage compartments. The 17 removable dividers can make from 4 to 21 compartments. Case has a carrying handle with 'snap fit' closures and clear lid. Sold loose.

Stock No.	Part No.	Dimensions
73507	QC21	460 x 325 x 80mm



2 5 to 26 Compartment Organiser

Plastic organiser with an adjustable matrix of storage compartments. The 21 removable dividers can make from 5 to 26 compartments. Case has a carrying handle with 'snap fit' closures and clear lid. Sold loose.

Stock No.	Part No.	Dimensions
73508	QC26	460 x 325 x 75mm



3 Multi-Compartment Organisers

Plastic organiser with an adjustable matrix of storage compartments. Case has a carrying handle with 'snap fit' closures and clear lid. Display packed.

Stock No.	Part No.	Dimensions
14716	QC12P	310 x 240 x 50mm



4 Double Sided Organiser

Double sided organiser with flexible configurable compartments ideal for storing a multitude of parts. Manufactured from high impact plastic with "snap-fit" closures this durable organiser is ideal for the garage, workshop and home. Display packed.

Stock No.	Part No.	Dimensions
31240	QCD34	320 x 260 x 80mm



6 15 Compartment Organiser

Plastic organiser with an adjustable matrix of lift - out storage compartments. Case has a carrying handle with 'snap fit' closures and clear lid. Sold loose.

Contents:

Configuration:

10 x compartments: 45 x 45 x 48mm

2 x compartments: 45 x 95 x 48mm

3 x compartments: 95 x 95 x 48mm

Stock No.	Part No.	Dimensions
25922	QC15D	315 x 275 x 60mm



5 8 Compartment Organiser

Plastic organiser with an adjustable matrix of lift - out storage compartments. Case has a carrying handle with 'snap fit' closures and clear lid. Sold loose.

Contents:

Configuration:

2 x compartments: 95 x 95 x 98mm

6 x compartments: 95 x 145 x 98mm

Stock No.	Part No.	Dimensions
25925	QC8D	415 x 330 x 110mm

7 22 Compartment Organiser

Plastic organiser with an adjustable matrix of lift - out storage compartments. Case has a carrying handle with 'snap fit' closures and clear lid. Sold loose.

Contents:

Configuration:

8 x Compartments: 45 x 45 x 48mm

10 x Compartments: 45 x 95 x 48mm

4 x Compartments: 95 x 95 x 48mm

Stock No.	Part No.	Dimensions
25924	QC22D	415 x 330 x 60mm



1
12 Drawer Organiser

Impact - resistant plastic ideal for use in the workshop or home. Latching facility to prevent drawer fall out. Slotted holes in cabinet to facilitate wall mounting. Shrink wrapped with display sleeve.

Contents:
Configuration:
8 x drawers: 53 x 134 x 38mm
4 x drawers: 105 x 134 x 53mm

Stock No.	Part No.	Dimensions
12014	POC12	260 x 160 x 230mm



2
30 Drawer Organiser

Impact - resistant plastic ideal for use in the workshop or home. Latching facility to prevent drawer fall out. Slotted holes in cabinet to facilitate wall mounting. Shrink wrapped with display sleeve.

Contents:
Configuration:
24 x drawers: 53 x 134 x 38mm
6 x drawers: 110 x 134 x 53mm

Stock No.	Part No.	Dimensions
12015	POC30	500 x 160 x 255mm



3
30 Drawer Storage Organiser

Expert Quality, steel framed organiser ideal for use in the home or workshop with 30 tough polypropylene drawers. Slotted holes are drilled in the cabinet to facilitate wall mounting. Overall size 307 x 146 x 375mm. Shrink wrapped.

Contents:
Configuration:
25 x drawers: 52 x 138 x 35mm
3 x drawers: 87 x 136 x 58mm
2 x drawers: 135 x 136 x 58mm

Stock No.	Part No.	Description
89470	QC30A	Organiser
68235	YQC 101981	30 Draw Dividers
68237	YQC 131681	52x35mm 16 Ass. Plastic Draw Dividers

4
30 Drawer 9 Bin Organiser

Organise your garage, workshop or home with this dual sized compartment organiser. Fitted with a latching facility on the drawers and designed for durability this organiser is ideal for storing all your bits and pieces. Display packed.

Contents:
Configuration:
30 x drawers: 52 x 138 x 35mm
9 x bins: 89 x 150 x 72mm

Stock No.	Part No.	Dimensions
31232	POC39	380 x 165 x 475mm





1

Medium Storage Unit Set (6 Piece)

Manufactured from heavy-duty plastic making them ideal for the garage, workshop and in sheds. Bin size - 105 x 135 x 82mm and supplied with plastic hanging rail. Display packed.

Stock No.	Part No.
38114	SBB1

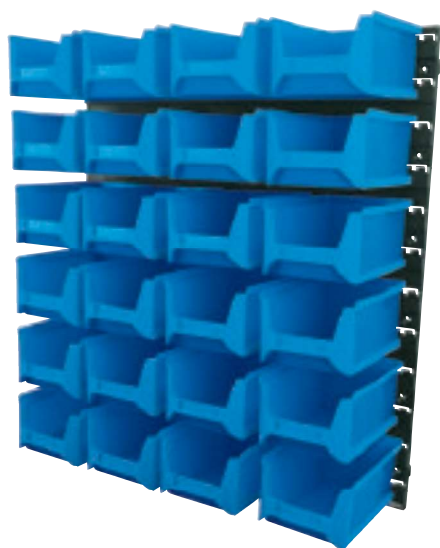

2

24 Bin Wall Storage Unit, Large Bins

Comprises 24 plastic storage bins - sized: 102 x 160 x 75mm that fix to a heavy duty plastic mounting board size 483 x 540mm. Ideal for industrial environments i.e. garages and workshops. Display carton.

Stock No.	Part No.
06797	SBB24B

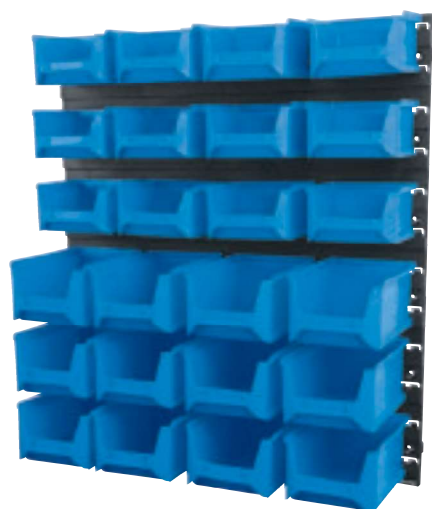

3

24 Bin Wall Storage Unit, Small/Medium Bins

Comprises 24 plastic storage bins - sizes: 12 medium 102 x 160 x 75mm and 12 small 102 x 100 x 75mm that fix to a heavy duty plastic mounting board size 483 x 540mm. Ideal for industrial environments i.e. garages and workshops. Display carton.

Stock No.	Part No.
06798	SBB24C

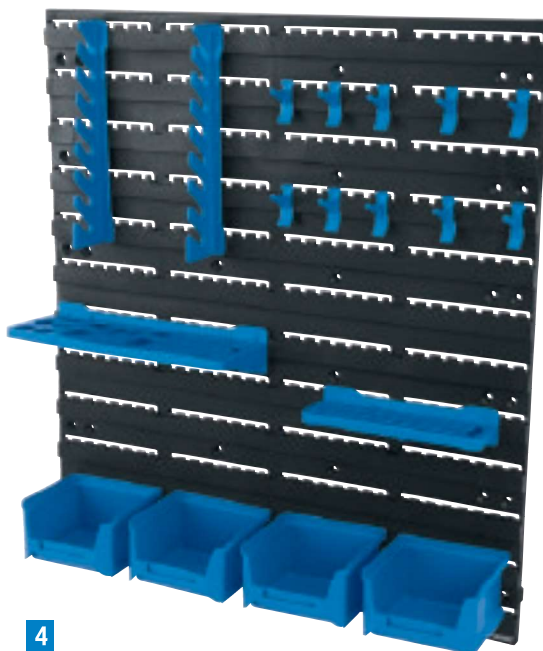
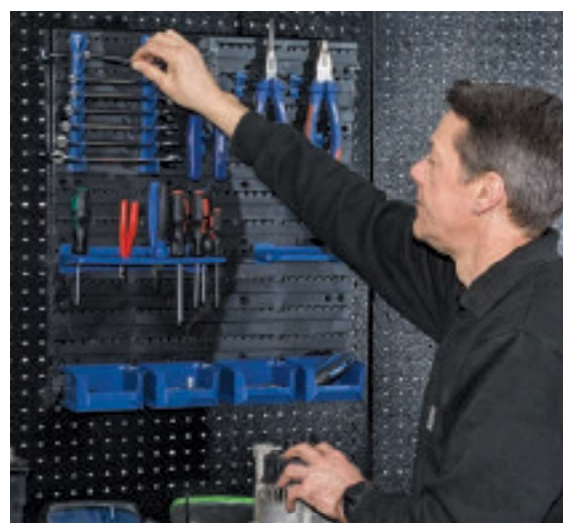

4

Tool Storage Board (18 Piece)

Wall mounted storage board with spanner holder, four bins, screwdriver holder, 10 hooks and insert bit holder. Bin sizes 102 x 100 x 60mm. Carton packed.

Stock No.	Part No.	Dimensions
22295	SBR18	483 x 540mm

SWITCH ON TO THE NEXT GENERATION OF MOBILE LIGHTING



Introducing the **NEW** Wireless Rechargeable Lighting Range from Draper



NEW COB/SMD LED Wireless Rechargeable Head Torch, 6W, 400 Lumens

- Adjustable head band
- IP65 dust and water resistance
- 4 brightness settings
- 4.5 hours charge time

NEW COB/SMD LED Wireless Rechargeable Mini Floodlight, 7W, 670 Lumens

- 180° rotating stand and carry handle
- IP65 dust and water resistance, and IK07 shock resistance, impact protection up to 2m
- 4 brightness settings
- 6 hours charge time

NEW Single & Dual Wireless Charging Pads

- Integrated screw holes for permanent fixing
- Built in magnets, mount to any magnetic surface Charge status LED
- Magnets in Lights for easy mounting and removal from charging bases
- Pop-out holder for mobile phone charging*

NEW SMD LED Wireless Rechargeable Hand Torch, 10W, 1000 Lumens

- Smart switches for easy mode selection
- IP68 dust and water resistance and IK07 shock resistance, impact protection up to 2m
- 4 brightness settings
- 4 hours charge time

Brilliant lighting when and wherever it's needed

Practical: charge single or multiple lights and other compatible devices

Simple: quick and easy charging in the workspace or on-the-go in a work van

Versatile: reliable lighting for a wide range of trades like plumbers, electricians, garages and farmers who need lights that are always ready for action

Robust: ultra tough nylon, aluminium & TPR construction, dust and shock resistant, ideal for challenging environments

See the full range on pages 791-802

*Mobile phone not included.



1 Heavy Duty Steel 4 Shelving Unit

Expert Quality, four shelf unit of robust construction manufactured from high quality steel ideal for industrial or domestic use. Wire construction shelves avoid collection of dust. Modular in design, different configurations can be achieved by changing layout. Each shelf can carry up to 364kg (evenly distributed) giving a total of 1456kg. Easily assembled, instructions supplied. An extension is available of similar dimensions to the main unit giving extra configurations (Stock No.05231). Carton packed.

Stock No.	Part No.	Dimensions
05230	MSUHD104/PRO	1040 x 610 x 1830mm



2 Heavy Duty Steel 4 Shelving Extension Unit

Expert Quality, four shelf extension unit of robust construction manufactured from high quality steel ideal for industrial or domestic use. Wire construction shelves avoid collection of dust. Modular in design, it conjoins Draper Shelving Unit Stock No. 05230 using a common upright. Each shelf can carry up to 364kg (evenly distributed) giving a total of 1456kg. Easily assembled, instructions supplied. Carton packed.

Stock No.	Part No.	Dimensions
05231	MSUHD104E/PRO	1040 x 610 x 1830mm



3 Heavy Duty Steel 4 Shelving Unit

Expert Quality, robust four shelf extension unit. Manufactured from high quality steel. Wire construction shelves avoid collection of dust. Modular in design. Each shelf can carry up to 364kg (evenly distributed) giving a total of 1456kg. Easily assembled with instructions supplied. An extension is available of similar dimensions to the main unit giving extra configurations (Stock No.05229). Carton packed on a pallet.

Deliveries of this product to outside of the UK mainland, Northern Ireland, The North of Scotland and the Republic of Ireland may incur a carriage cost, please ask for details before ordering.

Stock No.	Part No.	Dimensions
05227	MSUHD195/PRO	1959 x 610 x 1830mm



4 Heavy Duty Steel 4 Shelving Extension Unit

Expert Quality, robust four shelf extension unit. Manufactured from high quality steel. Wire construction shelves avoid collection of dust. Modular in design, it conjoins Draper Shelving Unit Stock No. 05227 using a common upright. Each shelf can carry up to 364kg (evenly distributed) giving a total of 1456kg. Easily assembled with instructions supplied. Carton packed on a pallet.

Deliveries of this product to outside of the UK mainland, Northern Ireland, The North of Scotland and the Republic of Ireland may incur a carriage cost, please ask for details before ordering.

Stock No.	Part No.	Dimensions
05229	MSUHD195E/PRO	1959 x 610 x 1830mm



1
**Heavy-Duty Steel Shelving Unit,
5 Shelves, L1220 x W610 x H1830mm**

Heavy-duty and robust steel shelving unit with five adjustable shelves. Coated in a powder finish to protect against corrosion. Each shelf can carry up to 580kg (evenly distributed) giving a total of 2900kg. Boltless for easy assembly. Dimensions: 1220 x 610 x 1830mm

Stock No.	Part No.	Dimensions
52958	MSUHD183	1040 x 610 x 1830mm



2
Heavy Duty Steel Shelving Unit

Expert Quality, five shelf unit of robust construction manufactured from high quality steel. Boltless for easy assembly. Ideal for industrial use. Each shelf can carry up to 225kg (evenly distributed) giving a total of 1125kg. Easily assembled, instructions supplied. Carton packed.

Stock No.	Part No.	Dimensions
21659	MSUHD183	920 x 305 x 1830mm



3
Heavy Duty Steel Shelving Unit

Expert Quality, five shelf unit of robust construction manufactured from high quality steel. Boltless for easy assembly. Each shelf can carry up to 225kg (evenly distributed) giving a total of 1125kg. Easily assembled, instructions supplied. Carton packed.

Stock No.	Part No.	Dimensions
21663	MSUHD183	1220 x 450 x 1830mm



4
Steel Shelving Unit

Four shelf unit of robust construction manufactured from quality steel. Boltless for easy assembly. Each shelf can carry up to 50kg (evenly distributed) giving a total of 200kg. Easily assembled, instructions supplied. Carton packed.

Stock No.	Part No.	Dimensions
21658	MSU152	760 x 300 x 1520mm



5
Car Boot Liner, 1.25 x 1.8m

Ideal for the prevention of damage to the inside of car boots, estate cars, SUVs etc. Hard wearing, waterproof and will wipe clean easily. Popper fastening with lifting handles. Polybag with header.

Stock No.	Part No.	Dimensions
47648	CBL/P	1.25 x 1.8m



1

Backpack Cool Bag, 15L

Ideal for a variety of outdoor activities. Main storage compartment has removable insulated foil lining for easy cleaning with non - insulated front storage compartment. Adjustable padded backstraps and heavy duty zips. Display carton.

Stock No.	Part No.	Dimensions
77589	CBBP	290 x 190 x 370mm



2

Tool Bags

Manufactured from water repellent polyester with PVC backing, fitted a nylon zip with framed opening. Open mouth design. Attached with 6 external and 13 internal pockets. Packed in polythene bag with display card.

Stock No.	Part No.	Dimensions
87358	TBS	320 x 210 x 230mm
87359	TBM	420 x 230 x 290mm



3

Open Mouth Tool Bag, 440mm

Open mouth design tool bag with 13 internal and 6 external pockets for excellent organisation potential. Fitted with a padded shoulder strap and grip handle for added user comfort. The solid base keeps tools safe from damage and protects the bag from moisture and dirt. Made from 600 denier hardwearing fabric that's strong and durable.

Stock No.	Part No.	Dimensions
35570	TBMHBJ	440 x 245 x 335mm





1
Hi-Vis Tool Bag, 600mm

Multi purpose tool bag. Manufactured from polyester with a robust solid base, hi - vis reflective strips, shoulder strap, 7 internal and 23 various sized exterior pockets. Display packed.

Stock No.	Part No.	Dimensions
31085	HVTB	600 x 280 x 260mm



2
Contractor's Tool Bag, 600mm

Expert Quality, water resistant canvas with PVC backing, reinforced handles, framed opening and reinforced base. 31 different - sized internal and external pockets for storing tools and accessories. Supplied with detachable shoulder strap and side strapping to accommodate a spirit level. Display packed.

Stock No.	Part No.	Dimensions
31591	TB650	600mm x 240mm x 295mm



3
Tool Bag on Wheels, 600mm

Manufactured from water repellent polyester with PVC backing on wheels with foldaway handle which retracts into base. Rope reinforced handles, nylon zip with framed opening and reinforced base with rubber grip squares. Many different - sized internal and external pockets for storing tools and accessories. Supplied with detachable shoulder strap. Sold loose with display card.

Contents:
Overall size: W 600 x D 300 x H 350mm
Weight: 2.97kg

Stock No.	Part No.	Dimensions
40754	TBW	600 x 300 x 350mm



4
Contractor's Tool Bag, 630mm

Manufactured from water repellent polyester with PVC backing, rope reinforced handles, nylon zip with framed opening and reinforced base with rubber grip squares. Many different - sized internal and external pockets for storing tools and accessories. Supplied with detachable shoulder strap and side strapping to accommodate a spirit level. Sold loose with display card.

Stock No.	Part No.	Dimensions
40755	TBB	630 x 280 x 350mm



5
Technician's Laptop Tool Case, 470mm

Manufactured from water repellent polyester with adjustable carrying handle and detachable shoulder strap. Multiple internal and external pockets for storing tools, equipment and computers etc. Packed in polythene bag with display card.

Stock No.	Part No.	Dimensions
89209	TBO	470 x 150 x 300mm



CONTENTS NOT INCLUDED





1 Tote Tool Bag, 420mm

Rigid nylon construction with solid base and soft grip on steel tubular handle, fifteen external pockets, ten internal pockets and eight elasticated tool holding loops. Supplied with adjustable shoulder straps and adjustable straps for builders level. Packed in polythene bag with insert card.

Stock No.	Part No.	Dimensions
85751	TTB/B	420 x 235 x 300mm



2 Folding Tote with Tubular Steel Handle, 355mm

Expert Quality, folding tubular frame construction with soft grip handle and covered in a rigid waterproof fabric. Incorporated with 8 external pockets and 14 internal pockets - loops. Fitted with shoulder strap and protective bumpers on the base. Display packed.

Stock No.	Part No.	Dimensions
31593	FTTB14	355 x 250 x 300mm



3 Folding Tote with Tubular Steel Handle, 610mm

Expert Quality, folding tubular frame with soft grip handle and covered in a rigid waterproof fabric. Incorporated with 8 external pockets and 18 internal tool loops. Fitted with shoulder strap and protective bumpers on the base. Display packed.

Stock No.	Part No.	Dimensions
31595	FTTB24	610 x 250 x 300mm



4 Draper Expert Canvas Tool Bag, 460 x 160 x 170mm

Expert Quality, manufactured from water repellent canvas with wrap around handles, nylon zip and wood baseboard. Packed in polythene bag with display card.

Stock No.	Part No.	Dimensions
72973	517A	460 x 160 x 170mm



5 600mm Canvas Tool Bag

Expert Quality, manufactured from water repellent canvas with PVC backing, rope reinforced handles, nylon zip and wood base. Packed in polythene bag with display card.

Stock No.	Part No.	Dimensions
72999	524A	600 x 170 x 180mm



6 Canvas Tool Bags

Manufactured from water resistant canvas, with heavy duty zip and wrap around strap handles. Packed in polythene bag with display card.

Stock No.	Part No.	Dimensions
72971	B519A	590 x 160 x 150mm
72972	B519A	460 x 180 x 195mm



7 Canvas Tool Bag, 740mm

Manufactured from water resistant canvas with buckle straps and canvas covered rope handles. Packed in polythene bag with display card.

Stock No.	Part No.	Dimensions
72970	B518A	740 x 210 x 220mm



8 14 Pocket Bucket-Shaped Bag

Multi-pocket nylon bucket-shaped bag with reinforced carrying handles, five internal pockets and eight external pockets. Fits to all standard shaped 12L buckets. Drawstring closure for security. Packed in polythene bag with insert card.

Stock No.	Part No.	Dimensions
02984	BB14	250 x 250mm



1
12 Division Tool Roll

Water - resistant polyester with ten storage pockets and two tool loops. Packed in polythene bag with display card.

Stock No.	Part No.	Dimensions
40767	TRP12	530 x 290mm



2
PVC Tool Rolls

Manufactured from PVC with bound edges and securing tapes. Packed in polythene bag with display card.

Stock No.	Part No.	Divisions	Dimensions
72976	TR8A	8	390 x 330mm
72977	TR14A	14	675 x 330mm



3
Multi-Pocket Tool Storage Roll

This high-quality multi-pocket tool roll is suitable for storing 14 tools, such as pliers and screwdrivers. There are two pocket sizes - 10 large and four medium. It is made from heavy-duty polyester and has an internal flap to protect the tools when folded. There is an additional wraparound webbed strap and a plastic clip to secure the roll when closed. It is an ideal portable storage solution for an electrician or mobile engineer. Overall size is 840 x 310mm.

Stock No.	Part No.
04802	TR14



4
Oil-Tanned leather Double Pouch Tool Belt

Expert Quality, oil tanned leather, reinforced with rivets and double stitched. Comprises two large pouches, knife holder, two hammer loops, two nail pouches, measuring tape holder and four screwdriver holders. Supplied with fully adjustable 50mm wide belt. Packed in polythene bag with insert card.

Stock No.	Part No.
03138	OTLTP/ND



5
Double Leather Tool Belt

Split suede leather, double - stitched. Comprising two large pockets, two medium pockets, six pencil pockets, two hammer loops, tape measure holder, holder for pliers and 50mm wide belt with 'quick release buckle'. Display carton.

Stock No.	Part No.
72921	TP11A



6
Heavy Duty Double Pouch Tool Belt

Expert Quality, rigid nylon, reinforced with rivets. Comprises two large pouches, three smaller pouches, measuring tape clasp, hammer loop, four leather tool holders and nylon tool holder. Supplied with 50mm fully adjustable fast click webbing belt. Display carton.

Stock No.	Part No.
02985	DTP/HD



7
Double Pouch Tool Belt

Polyester double stitched construction. Comprising three pouches with multiple pockets of varying sizes, two hammer loops, tool sleeve and 50mm wide belt with 'quick release buckle'. Packed in polythene bag with display card.

Stock No.	Part No.
03068	DTP



1
16 Pocket Tool Pouch

Nylon tool pouch, comprising 16 pouches of varying sizes, hammer loop, measuring tape clasp and chain. Supplied with 50mm wide adjustable webbing belt. Display carton.

Stock No.	Part No.
02987	TP24



2
Double Pocket Nail Pouch, Yellow

First quality split suede leather single stitched with 40mm wide nylon belt. Packed in polythene bag with display card.

Stock No.	Part No.
72920	DNPA



3
Polypropylene Webbing Belt

Fully adjustable, with locking clip. 1200mm long (approx.) x 50mm wide. Will fit the Draper range of Tool Pouches and Holsters. Display packed.

Stock No.	Part No.
72925	NBA



4
Swivelling Hammer Loop

Top grain leather. Nickel plated steel loop with swivel action attached by reinforced rivets. Slots suitable for belts up to 50mm. Display packed.

Stock No.	Part No.
72924	SHLA



5
Scaffold Spanner Holder

Top grain leather with reinforced rivets securing the hanging hole and two 60mm belt slots. Display packed.

Stock No.	Part No.
20612	SSH



6
Work Braces

Ideally suited for attaching to trousers or the belt on heavy tool pouches. The braces help to support the heavy tool pouch on the belt by evenly distributing load, particularly useful when working on ladders or scaffolding. The front straps are polypropylene with elasticated rear straps and nickel plated buckles. Display packed.

Stock No.	Part No.
39243	HDB



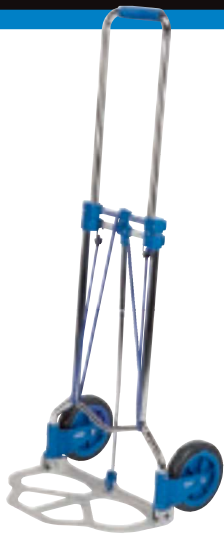

1 Heavy Duty Fold Flat Sack Truck, 125kg

- Foldable and extendable sack truck
- Extremely versatile sack truck manufactured with a comfortable foam grip handle attached to a heavy-duty tubular steel frame
- Fitted with a 490 x 450mm cast aluminium base plate
- Max load 125kg
- Fitted with a safety pin feature helping prevent wheel closure

Extended height:	1250mm
Maximum capacity:	125kg (flat/level surface)
Base plate size:	490 x 280mm (flat)

Available in singles - order multiples of 5 to get a free floor dispenser

Stock No.	Part No.	Weight
80805	DHTHD	125kg



2 Fold Flat Sack Truck, 90kg

- 90kg maximum load capacity
- High quality tubular steel frame
- Heavy duty cast aluminium nonslip base plate
- Easy fold and extend action
- Integral safety pin feature to prevent accidental closure
- Foam grip handle for user comfort
- Folds flat to 58mm for easy storage

Closed height:	705mm
Extended height:	1020mm
Flat closed size:	58mm
Maximum capacity :	90kg (flat/level surface)
Base plate size:	480 x 280mm (flat)

Available in singles - order multiples of 5 to get a free floor dispenser

Stock No.	Part No.	Weight
68854	DHT	90kg



3 Heavy Duty Sack Truck

- Tubular steel frame with pneumatic tyres
- Max. load: 250kg

Capacity :	250kg
Toe plate size:	253 x 355mm
Toe plate thickness:	4mm
Unladen weight:	11kg
Overall size L x W x H:	1220 x 530 x 487mm

Stock No.	Part No.	Description
85670	DST5/T	Sack Truck
62021	YDST5	Spare Wheel



4 3 in 1 Heavy Duty Sack Truck

- Tubular steel frame
- Pneumatic tyres
- Converts to three positions

Capacity wheels + castors:	300kg
Capacity just wheels:	250kg
Toe plate size:	400 x 300mm
Toe plate thickness:	4mm
Unladen weight:	20.85kg
Overall size L x W x H:	1275 x 614 x 560mm

Stock No.	Part No.	Description
85673	DST3/T	Sack Truck
63358	YDST3	Spare Wheel



5 Heavy Duty Stair Climbing Sack Truck

- Manufactured from tubular steel
- Attached with a triangular three wheel axle
- Wheels fitted with solid rubber tyres
- Compact frame folds up for easy storage and transportation
- Maximum load capacity of 150kg

Capacity :	150kg
Toe plate size:	370 x 280mm
Unladen weight:	13kg
Overall size L x W x H:	1140 x 530 x 760mm

Stock No.	Part No.	Description
85675	DSCT/T	Sack Truck
63358	YDST3	Spare Wheel



1 Pallet Truck, 2.5 Tonne

• Ideal for use in warehouse environments

Capacity:	2,500kg
Minimum fork height:	85mm
Maximum fork height:	200mm
Lift height:	672mm
Fork length:	1150mm
Fork width:	540mm
Load wheel quantity:	4
Steering wheel quantity:	2
Load wheel size:	80 x 70mm
Steering wheel size:	200 x 50mm
Wheel material:	Rubber
Nett Weight:	72kg

Stock No.	Part No.
85655	PT2500-B



2 Platform Trolley with Folding Handle, 630 x 480 x 850mm, 150kg

Tough steel construction with rubber protective edges. Heavy duty matting on carrying surface and four heavy duty rubber tyred castors (two fixed and two swivelling). Handle folds away for convenient storage. Carton packed.

Stock No.	Part No.	Dimensions
44005	FRT	630 x 480 x 850mm



3 Platform Trolley with Folding Handle, 900 x 600 x 850mm, 300kg

Tough steel construction with rubber protective edges. Heavy duty matting on carrying surface and four heavy duty rubber tyred castors (two fixed and two swivelling). Handle folds away for convenient storage. Carton packed.

Stock No.	Part No.	Dimensions
04692	FRT300	900 x 600 x 850mm



4 3 Wheel Dolly

Ideal for moving furniture and loads up to 60 kg and fitted with three casters which deliver fantastic manoeuvrability. The stable Aluminium base is cushioned helping protect items while being transported.

Stock No.	Part No.
15078	3WD



5 Folding Step Stool

Plastic folding step stool with anti-slip grips on the top. Folds flat for easy storage. Height 235mm. Maximum capacity of 125kg. Sold loose with display label.

Stock No.	Part No.
19258	FSST



6 Metal Kickstool

GS and TUV Approved
Two level, with spring suspension with instant set down once weight is applied. Three castor wheels. Maximum weight 150kg. Display carton.

Stock No.	Part No.	Height
59246	KS	440mm



1

Pair of Fold Down Trestles, 1000 x 800mm

Pair of trestles for supporting large workpieces, doors, etc. Pressed steel with anti-slip mat on top and side surfaces and a rubber foot on each leg. Trestles fold down for safe storage. Maximum loading 200kg, evenly distributed. Display carton.

Stock No.	Part No.	Dimensions
52072	TRY2	1000 x 780mm



2

Telescopic Trestle/Saw Horse

Telescopic action with height adjusting locking bars. Dual locking safety arms and folding support braces for rigidity when working. Folds down for safe storage. Manufactured from heavy-duty box section steel. Maximum loading 250kg. Supplied in kit form with assembly instructions for easy self - assembly. Display carton.

Stock No.	Part No.	Dimensions
54051	BT/Y1	685 x 810-1300mm

3

Pair of Telescopic Trestle/Saw Horse

Telescopic action with height adjusting locking bars. Dual locking safety arms and folding support braces for rigidity when working. Trestles fold down for safe storage. Manufactured from heavy - duty box section steel. Maximum loading 250kg evenly distributed. Supplied in kit form with assembly instructions for easy self - assembly. Display carton.

Stock No.	Part No.	Dimensions
54053	BT/Y2	685 x 810-1300mm



1
Fold Down Workbench, 600mm

Portable workbench with dual clamping action and 24 holes for work clamping dogs. Folds flat for secure storage. Two - piece MDF worktop. Sturdy legs manufactured from strong box section steel. Maximum clamping width with dogs 260mm. Supplied with four plastic clamping dogs and fixings. Weight 7.5kg.(approx.). Flat packed with assembly instructions. Display carton.

Stock No.	Part No.	Dimensions
77020	WB600Y	600 x 640 x 785mm



2
Fold Down Workbench, 800mm

Portable workbench with dual clamping action and 35 holes for work clamping dogs. Folds flat for secure storage. Two - piece MDF worktop. Sturdy legs manufactured from strong box section steel. Maximum clamping width with dogs 430mm. Supplied with four plastic clamping dogs and fixings. Weight 11.5kg.(approx.). Flat packed with assembly instructions. Display carton.

Stock No.	Part No.	Dimensions
21353	WB800Y	805 x 650 x 785mm



3
Tilt & Clamp Fold Down Workbench, 600mm

Portable workbench with dual clamping action and 24 holes for work clamping dogs. Special tilting two - piece MDF worktops allow 0°, 45° and 90° clamping. Folds flat for secure storage. Sturdy legs manufactured from strong box section steel. Maximum clamping width with dogs 280mm. Supplied with four plastic clamping dogs and fixings. Weight 6.1kg.(approx.). Flat packed with assembly instructions. Display carton.

Stock No.	Part No.	Dimensions
09951	WBTT600Y	600 x 650 x 800mm



4
Twin Height Heavy Duty Fold Down Workbench, 650mm

Heavy duty professional workbench with twin height settings for user convenience. Manufactured with two - piece MDF worktop, with quick release jaw function, angled steel legs and anti slip feet, dual clamping action and 12 clamping dog holes. Maximum clamping width with clamping dogs of 380mm. Supplied with four plastic clamping dogs. Easily folds away for secure storage and portability. Weight 13kg (approx.). Flat packed with assembly instructions. Display carton.

Stock No.	Part No.	Dimensions
38121	HDWB/YR	650 x 710 x 790mm



1
Steel Workbench

Manufactured from sheet steel with a powder coated finish with MDF worktop. Easy-to-assemble as there are no nuts and bolts. Maximum working load 200kg. Supplied in flat packed form with assembly instructions. Display packed.

Stock No.	Part No.	Dimensions
24912	WB1200	1200 x 600 x 900mm

2
Steel Workbench

Manufactured from sheet steel with a powder coated finish with MDF worktop. Easy-to-assemble as there are no nuts and bolts. Maximum working load 200kg. Supplied in flat packed form with assembly instructions. Display packed.

Stock No.	Part No.	Dimensions
24913	WB1800	1800 x 600 x 900mm



3
Aluminium Ladder Stand Off

- Anti-slip rubber pads.
- Securing lock spring.

Stand off width:	640mm
Stand off from wall to ladder:	340mm
Ladder bracket width:	205mm
Ladder bracket height:	340mm

Stock No.	Part No.
23211	LSO



4
Ladder Car Roof Clamps

Easy way of securing ladders and steps to car roof racks. Cross beams clamp ladders securely to roof rack by simple spinner handles. Quick and easy tool-free installation. Lock holes for additional security if a padlock is required. Display packed.

Stock No.	Part No.
24807	LRC



5
Ladder Lock

Universal ladder lock giving a practical system for the safe, convenient and secure storage of most ladders. Hooks come complete with a locking bar for additional security if a padlock is required. Two brackets are approximately 225 x 170mm. Display packed.

Stock No.	Part No.	Capacity
24808	LLOCK	30kg



DRAPER[®]

**WE'RE AS PASSIONATE ABOUT
QUALITY TOOLS AS YOU ARE!**

We offer a wide range of essential tools that cater to all trades, from electricians through to mechanics. Our hand tools are rigorously tested by our in-house quality assurance team, include a Lifetime Warranty, and meet all relevant quality and safety standards.



Hand Tools



Power Tools



Cement Mixers



Wheelbarrows



Breakers



Storage

1

Plumbing Tool Kit

Comprehensive kit for plumbers.

Contents:

- 1 x Tube bender
- 1 x Automatic pipe cutter, 15mm
- 1 x Automatic pipe cutter, 22mm
- 1 x Hammer
- 1 x Tap re-seating tool
- 1 x Adjustable pipe wrench
- 1 x Trimming knife
- 1 x Measuring tape
- 1 x Screwdriver set (16 Piece)
- 1 x Junior hacksaw
- 1 x Hacksaw
- 1 x Handsaw
- 1 x Pipe cutter
- 2 x Waterpump pliers
- 1 x Contractors tool bag
- 1 x File set (3 Piece)
- 1 x Pliers set (3 Piece)
- 1 x Spirit level
- 2 x Adjustable wrench
- 1 x 3-Way Radiator key
- 2 x Manhole keys
- 1 x Master utility key
- 2 x Adjustable basin wrench
- 2 x Immersion heater wrench
- 1 x Basin wrench
- 1 x Plastic pipe cutter

Draper Tools reserves the right to substitute items in the kit of equivalent finish or quality if the original item quoted in the above list has been discontinued or is out of stock.

Stock No.	Part No.
04380	DTKPLUMBTK



2

Automotive Electricians Tool Kit

Comprehensive kit for automotive electricians.

Contents:

- 1 x Digital multimeter Plier set in EVA insert (5 Piece)
- 1 x VDE plier set in EVA insert (4 Piece)
- 1 x VDE screwdriver set in EVA insert (11 Piece)
- 1 x Precision screwdriver set in EVA insert (8 Piece)
- 1 x Insert bit set in EVA insert (40 Piece)
- 1 x Combination spanner set in EVA insert (12 Piece)
- 1 x 1/4" Socket set in EVA insert (32 Piece)
- 1 x 3/8" Socket set in EVA insert (35 Piece)
- 1 x Rechargeable inspection lamp
- 1 x Ratchet crimping tool kit
- 1 x 6-24V DC circuit tester
- 1 x 5 Drawer tool chest

Draper Tools reserves the right to substitute items in the kit of equivalent finish or quality if the original item quoted in the above list has been discontinued or is out of stock.

Stock No.	Part No.
03564	DTKBLUEEK



1

Electricians Tote Bag Tool Kit

Comprehensive kit for electricians.

Contents:

- 1 x Pipe Cutter
- 1 x Security Screwdriver Bit and Driver Set (45 piece)
- 1 x 13A Socket Tester
- 1 x Junior Hacksaw
- 1 x Claw Hammer
- 1 x Handsaw
- 1 x Tote Tool Bag
- 1 x File Set (3 Piece)
- 1 x Ergo Plus® VDE Screwdriver Set with Interchangeable Blades (18 Piece)
- 1 x Plasterboard Saw
- 1 x Master Utility Key
- 1 x Waterpump Pliers
- 1 x Cable Access Kit
- 1 x Re-Threading Tool
- 1 x Cable Cutter

Draper Tools reserves the right to substitute items in the kit of equivalent finish or quality if the original item quoted in the above list has been discontinued or is out of stock.

Stock No.	Part No.
04319	DTKELECTKB



2

Electricians Tool Kit

Comprehensive kit with robust lacquered sheet steel four tray cantilever tool box size 530 x 200 x 210mm.

Contents:

- 1 x Safety spectacles
- 1 x Brick bolster with hand guard
- 1 x Junior hacksaw blades
- 1 x Retractable trimming knife
- 1 x Roll of black insulation tape
- 1 x Cold chisel with hand guard
- 1 x Flat wood bit set
- 1 x Claw hammer
- 1 x Holesaw kit
- 1 x Combined HSS and masonry drill set
- 1 x Hacksaw frame and two bi-metal blades
- 1 x Ratchet crimping tool
- 1 x Terminal assortment
- 1 x Precision screwdriver set
- 1 x Hickory shaft club hammer
- 1 x Adjustable wrench
- 1 x 7.5M/25ft measuring tape
- 1 x Assorted nylon cable tie pack
- 1 x Socket and bit set with flexible shaft driver
- 1 x VDE approved euro mains tester
- 1 x Digital multimeter
- 1 x Combined metal
- 1 x voltage and stud detector
- 1 x Head lamp
- 1 x Floorboard saw
- 1 x Electricians pocket knife
- 1 x Soft grip hardpoint plasterboard saw
- 1 x VDE approved fully insulated wire stripping pliers
- 1 x VDE approved fully insulated waterpump pliers
- 1 x Mini saw with powder coated frame
- 1 x Boat level
- 1 x VDE approved fully insulated pliers and screwdriver set
- 1 x Soldering kit
- 1 x Heavy duty rubber torch
- 1 x Bevel edge wood chisel set
- 1 x Engineers file set
- 1 x Carpenters awl

Draper Tools reserves the right to substitute items in the kit of equivalent finish or quality if the original item quoted in the above list has been discontinued or is out of stock.

Stock No.	Part No.
89756	DTKELEC

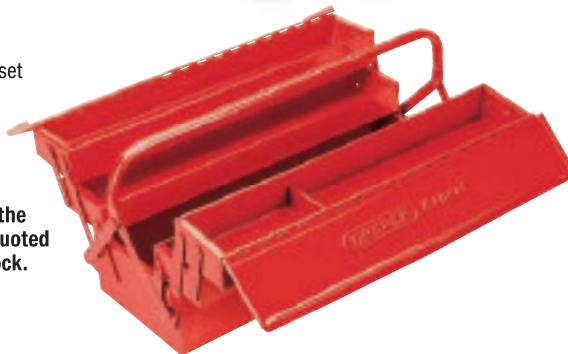



1 Workshop Tool Kit (A)

Comprises six drawer narrow pattern tool chest (size 600 x 260 x 340mm) with a selection of hand tools suitable for use in the workshop.

Contents:

- 1 x Adjustable wrench
- 1 x Combination plier
- 1 x Combination spanner set
- 1 x Combined socket set
- 1 x Crimping tool kit
- 1 x Diagonal side cutter
- 1 x Feeler gauge set
- 1 x Hacksaw
- 1 x Hacksaw blades
- 1 x Hexagon key set
- 1 x Junior hacksaw
- 1 x Junior hacksaw blades
- 1 x Measuring tape
- 1 x Mechanic's bit set
- 1 x Pack of latex gloves
- 1 x Pry bar set
- 1 x Radio plier
- 1 x Rubber mallet
- 1 x Screwdriver set
- 1 x Self grip plier
- 1 x Tinman's shears
- 1 x Trimming knife
- 1 x Trimming knife blades
- 1 x Waterpump plier
- 1 x Wire scratch brush

Draper Tools reserves the right to substitute items in the kit of equivalent finish or quality if the original item quoted in the above list has been discontinued or is out of stock.

Stock No.	Part No.
50104	DTKTK2A



EVA FOAM INSERT TRAYS

Our range of modular, mix and match EVA foam insert trays allows you to manage your tools more easily. Designed to fit into Draper Expert and Draper tool chests and cabinets whilst also fitting other manufacturers similar storage units. Turn to pages 101-110 for more details.



1 Workshop Tool Kit (B)

Comprises six drawer narrow pattern tool chest (size 600 x 260 x 340mm) with a selection of hand tools suitable for use in the workshop.

Contents:

- | | |
|---|---------------------------|
| 1 x Adjustable wrench | 1 x Junior hacksaw blades |
| 1 x Cold chisel and punch set | 1 x Measuring tape |
| 1 x Combination plier | 1 x Mechanic's bit set |
| 1 x Combination spanner set | 1 x Pack of latex gloves |
| 1 x Combined socket set | 1 x Pry bar set |
| 1 x Crimping tool kit | 1 x Radio plier |
| 1 x Diagonal side cutter | 1 x Round file and handle |
| 1 x Digital automotive analyser | 1 x Rubber mallet |
| 1 x Draper TX-STAR® security driver set | 1 x Screwdriver set |
| 1 x Feeler gauge set | 1 x Self grip plier |
| 1 x Flat file and handle | 1 x Tinman's shears |
| 1 x Hacksaw | 1 x Torque wrench |
| 1 x Hacksaw blades | 1 x Trimming knife |
| 1 x Half round file and handle | 1 x Trimming knife blades |
| 1 x Hexagon key set | 1 x Waterpump plier |
| 1 x Junior hacksaw | 1 x Wire scratch brush |

Draper Tools reserves the right to substitute items in the kit of equivalent finish or quality if the original item quoted in the above list has been discontinued or is out of stock.

Stock No.	Part No.
53205	DTKTKC2B





1
Workshop General Tool Kit (C)

Comprises combined roller cabinet chest (size 616 x 330 x 1080mm) with a selection of tools suitable for use in the workshop.

Contents:

- 2 x Adjustable wrenches
- 1 x 230V Fluorescent inspection lamp
- 1 x 230V Hammer drill
- 1 x Bent nose long reach long nose plier
- 1 x Circlip plier set
- 1 x Cold chisel and punch set
- 1 x Combination plier
- 1 x Combination spanner set
- 1 x Combined socket set
- 1 x Crimping tool kit
- 1 x Diagonal side cutter
- 1 x Digital automotive analyser
- 1 x Draper TX-STAR® security driver set
- 1 x Drill and accessory kit
- 1 x Feeler gauge set
- 1 x Flat file and handle
- 1 x Hacksaw
- 1 x Hacksaw blades
- 1 x Half round file and handle
- 1 x Inspection mirror
- 1 x Junior hacksaw
- 1 x Junior hacksaw blades
- 1 x Long reach long nose plier
- 1 x Magnetic parts tray
- 1 x Magnetic pick up tool
- 1 x Measuring tape
- 1 x Mechanic's bit set
- 1 x Pack of latex gloves
- 1 x Pocket multi-tool
- 1 x Pry bar set
- 1 x Radio plier
- 1 x Riveter kit
- 1 x Round file and handle
- 1 x Rubber mallet
- 1 x Screwdriver set
- 1 x Self grip plier
- 1 x Tinman's shears
- 1 x Torque wrench
- 1 x Trimming knife
- 1 x Trimming knife blades
- 1 x Waterpump plier
- 1 x Wire scratch brush

Draper Tools reserves the right to substitute items in the kit of equivalent finish or quality if the original item quoted in the above list has been discontinued or is out of stock.

Stock No.	Part No.
50924	DTKGK2A





1 Workshop Tool Kit (D)

Comprises combined roller cabinet chest (size 616 x 330 x 1080mm) with a selection of tools suitable for use in the workshop.

Contents:

- | | |
|--|--------------------------------|
| 2 x Adjustable wrenches | 1 x Inspection mirror |
| 2 x Flat metal cutting wheels | 1 x Junior hacksaw |
| 1 x 230V Angle grinder | 1 x Junior hacksaw blades |
| 1 x 230V Fluorescent inspection lamp | 1 x Long nose self grip plier |
| 1 x 230V Hammer drill | 1 x Long reach long nose plier |
| 1 x Bent nose long reach long nose plier | 1 x Magnetic parts tray |
| 1 x Circlip plier set | 1 x Magnetic pick up tool |
| 1 x Cold chisel and punch set | 1 x Measuring tape |
| 1 x Combination plier | 1 x Mechanic's bit set |
| 1 x Combination spanner set | 1 x Pack of latex gloves |
| 1 x Combined socket set | 1 x Pocket multi-tool |
| 1 x Crimping tool kit | 1 x Pry bar set |
| 1 x Diagonal side cutter | 1 x Radio plier |
| 1 x Digital automotive analyser | 1 x Riveter kit |
| 1 x Draper TX-STAR® Security driver set | 1 x Round file and handle |
| 1 x Draper TX-STAR® sockets | 1 x Rubber mallet |
| 1 x Drill and accessory kit | 1 x Screwdriver set |
| 1 x Feeler gauge set | 1 x Self grip plier |
| 1 x Flat file and handle | 1 x Tinman's shears |
| 1 x Hacksaw | 1 x Torque wrench |
| 1 x Hacksaw blades | 1 x Trimming knife |
| 1 x Half round file and handle | 1 x Trimming knife blades |
| 1 x Impact screwdriver set | 1 x Waterpump plier |
| | 1 x Wire scratch brush |

Draper Tools reserves the right to substitute items in the kit of equivalent finish or quality if the original item quoted in the above list has been discontinued or is out of stock.

Stock No.	Part No.
53219	DTKGTK2B





1
Workshop Tool Kit (E)

Comprises combined roller cabinet chest (size 616 x 330 x 1080mm) with a selection of hand and power tools suitable for use in the workshop.

Contents:

- | | | |
|--|---|--|
| 2 x Adjustable wrenches | 1 x Digital automotive analyser | 1 x Measuring tape |
| 2 x Feeler gauge sets | 1 x Draper TX-STAR® security driver set | 1 x Mechanic's bit set |
| 2 x Flat metal cutting wheels | 1 x Draper TX-STAR® sockets | 1 x Pack of ten sanding sheets |
| 1 x 230V Angle grinder | 1 x Drill and accessory kit | 1 x Pry bar set |
| 1 x 230V Fluorescent inspection lamp | 1 x Engineers file set | 1 x Ratchet crimping tool |
| 1 x 230V Hammer drill | 1 x Hacksaw | 1 x Ratcheting combination spanner set |
| 1 x 230V Orbital sander | 1 x Hacksaw blades | 1 x Riveter with rivets |
| 1 x Bent nose long reach long nose plier | 1 x Impact screwdriver set | 1 x Rubber mallet |
| 1 x Box of latex gloves | 1 x Inspection mirror | 1 x Rubber torch |
| 1 x Chisel and punch set | 1 x Junior hacksaw | 1 x Screwdriver set |
| 1 x Circlip plier set | 1 x Junior hacksaw blades | 1 x Self grip pliers set |
| 1 x Combination plier | 1 x Long nose plier | 1 x Tinman's shears |
| 1 x Combination spanner set | 1 x Long reach long nose plier | 1 x Torque wrench |
| 1 x Combined socket set | 1 x Magnetic pick up tool | 1 x Trimming knife |
| 1 x Crimping terminal assortment | | 1 x Trimming knife blades |
| 1 x Diagonal side cutter | | 1 x Waterpump plier |
| | | 1 x Wire scratch brush |

Draper Tools reserves the right to substitute items in the kit of equivalent finish or quality if the original item quoted in the above list has been discontinued or is out of stock.

Stock No.	Part No.
51286	DTKPTK2A



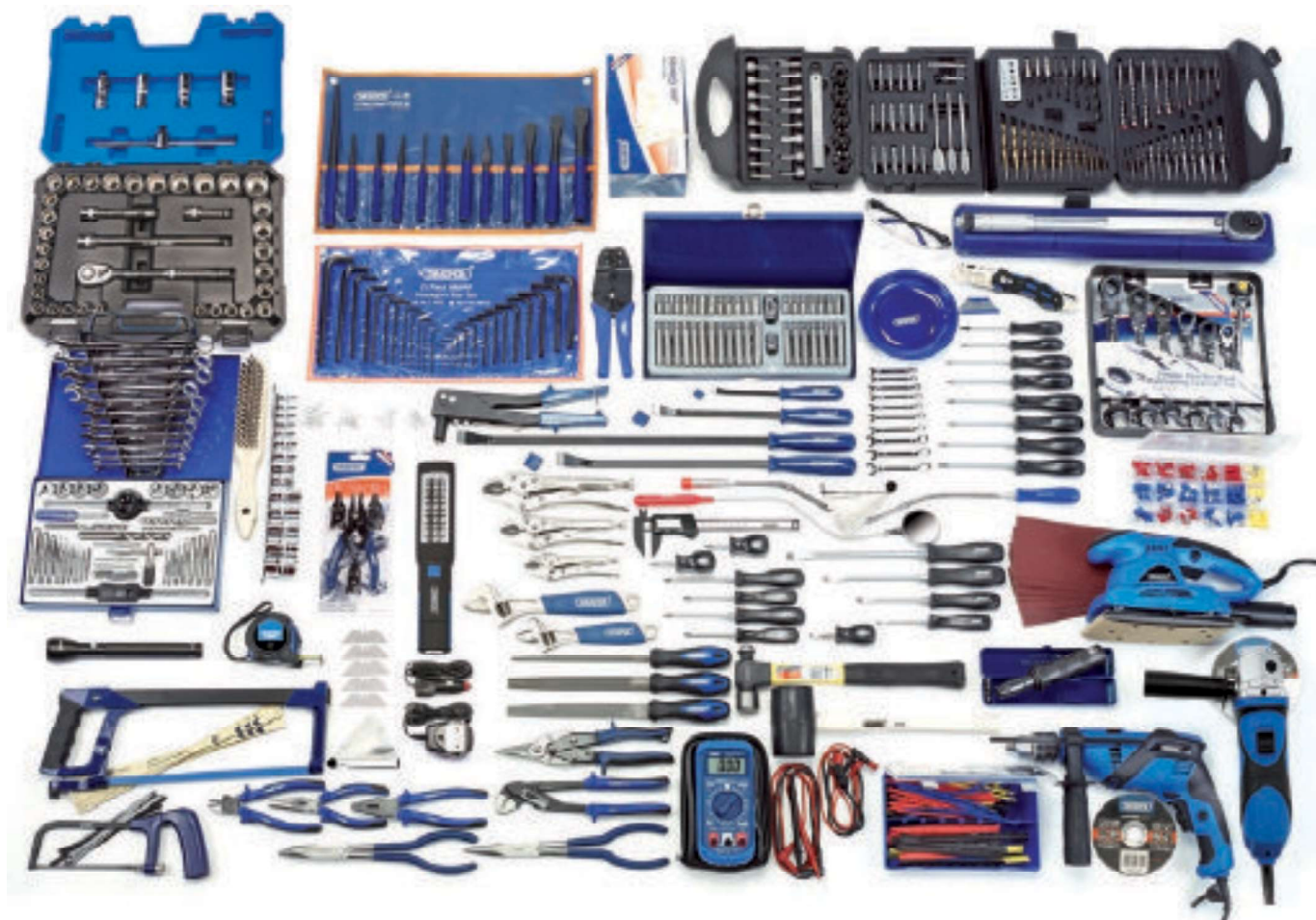

1 Workshop Tool Kit (F)

Comprises combined roller cabinet chest (size 616 x 330 x 1080mm) with a selection of hand and power tools suitable for use in the workshop.

Contents:

- | | | |
|--|---|--|
| 2 x Adjustable wrenches | 1 x Digital automotive analyser | 1 x Magnetic pick up tool |
| 2 x Feeler gauge sets | 1 x Digital caliper gauge | 1 x Measuring tape |
| 2 x Flat metal cutting wheels | 1 x Draper TX-STAR® security driver set | 1 x Mechanic's bit set |
| 1 x 230V Angle grinder | 1 x Draper TX-STAR® sockets | 1 x Pack of ten sanding sheets |
| 1 x 230V Fluorescent inspection lamp | 1 x Drill and accessory kit | 1 x Pry bar set |
| 1 x 230V Hammer drill | 1 x Engineers file set | 1 x Ratchet crimping tool |
| 1 x 230V Orbital sander | 1 x Hacksaw | 1 x Ratcheting combination spanner set |
| 1 x Ball pein hammer | 1 x Hacksaw blades | 1 x Riveter with rivets |
| 1 x Bent nose long reach long nose plier | 1 x Heat shrink tube assortment | 1 x Rubber mallet |
| 1 x Box of latex gloves | 1 x Hexagon key set | 1 x Rubber torch |
| 1 x Chisel and punch set | 1 x Impact screwdriver set | 1 x Safety spectacles |
| 1 x Circlip plier set | 1 x Inspection mirror | 1 x Screwdriver set |
| 1 x Combination plier set | 1 x Junior hacksaw blades | 1 x Self grip pliers set |
| 1 x Combination spanner set | 1 x Junior hacksaw blades | 1 x Tap and die set |
| 1 x Combination spanner set | 1 x Long nose plier | 1 x Tin Snips |
| 1 x Combined socket set | 1 x Long reach long nose plier | 1 x Torque wrench |
| 1 x Crimping terminal assortment | 1 x Magnetic parts tray | 1 x Trimming knife blades |
| 1 x Diagonal side cutter | | 1 x Trimming knife blades |
| | | 1 x Waterpump plier |
| | | 1 x Wire scratch brush |

Draper Tools reserves the right to substitute items in the kit of equivalent finish or quality if the original item quoted in the above list has been discontinued or is out of stock.

Stock No.	Part No.
53257	DTKPTK2B





1
Workshop Engineers Tool Kits

Comprehensive kit for workshop engineers.

Contents:

- 1 x Circlip plier set in EVA insert (5 Piece)
- 1 x Pliers set in EVA insert (4 Piece)
- 1 x Draper TX-STAR® security screwdriver set in EVA insert(11 Piece)
- 1 x Screwdriver insert bit set in EVA insert (40 Piece)
- 1 x Tap and Die set in EVA insert (22 Piece)
- 1 x 1/4", 3/8", 1/2" Socket set in EVA insert (84 Piece)
- 1 x Tool kit in EVA insert (5 Piece)
- 1 x Rechargeable magnetic inspection lamp
- 1 x Nitrile gloves
- 1 x Safety glasses
- 1 x Hacksaw
- 1 x Ball pein hammer
- 1 x Crimping tool and terminal kit
- 1 x 6 Drawer tool chest

Draper Tools reserves the right to substitute items in the kit of equivalent finish or quality if the original item quoted in the above list has been discontinued or is out of stock.

Stock No.	Part No.
03609	DTKBLUEWEK



DRAPER
Expert



1 Workshop Tool Kit (H)

Comprises 7 drawer roller tool cabinet and a 6 drawer tool chest with a selection of mostly Expert Quality hand tools for use in the automotive workshop.

Contents:

- | | |
|---|--|
| 1 x 1/2" Sq. Dr. Combined socket set | 1 x Hacksaw blades |
| 1 x 1/4" Sq. Dr. Socket and bit set | 1 x Long nose plier |
| 1 x 3/8" Sq. Dr. Socket and bit set | 1 x Magnetic pick-up tool |
| 2 x Adjustable wrenches | 1 x Mechanic's bit set |
| 3 x Extra long screwdrivers | 1 x Ratchet crimping tool |
| 1 x Circlip plier set | 1 x Reversible double ratcheting combination spanner set |
| 1 x Combination plier | 1 x Riveter |
| 1 x Combination spanner set | 1 x Screwdriver set |
| 1 x Combination tap and die set | 1 x Self grip plier set |
| 1 x Crimp Terminal assortment | 1 x Side cutter |
| 1 x Deep offset ring spanner set | 1 x Tinman's shears |
| 1 x Draper TX-STAR® security key set | 1 x Trimming knife |
| 1 x Draper TX-STAR® sockets | 1 x Trimming knife blades |
| 1 x Flexible head double ratcheting combination spanner set | 1 x Waterpump plier |
| 1 x Hacksaw | |

Draper Tools reserves the right to substitute items in the kit of equivalent finish or quality if the original item quoted in the above list has been discontinued or is out of stock.

Stock No.	Part No.
98885	DTKDTK2019A

DRAPER
SUPPLIED ON
PALLET





1
Workshop Tool Kit (I)

Comprises 7 drawer roller tool cabinet and a 6 drawer tool chest with a selection of mostly Expert Quality hand tools for use in the automotive workshop.

Contents:

- 1 x 1/4" Sq. Dr. Socket and bit set
- 1 x 3/8" Sq. Dr. Socket and bit set
- 2 x Adjustable wrenches
- 1 x Circlip plier set
- 1 x Combination plier
- 1 x Combination spanner set
- 1 x Crimp Terminal assortment
- 1 x Deep offset ring spanner set
- 1 x Draper TX-STAR® security key set
- 1 x Draper TX-STAR® sockets
- 1 x Flexible head double ratcheting combination spanner set
- 1 x Hacksaw
- 1 x Hacksaw blades
- 1 x Long nose plier
- 1 x Magnetic pick-up tool
- 1 x Mechanic's bit set
- 1 x Ratchet crimping tool
- 1 x Reversible double ratcheting combination spanner set
- 1 x Riveter
- 1 x Screwdriver set
- 1 x Self grip plier set
- 1 x Side cutter
- 1 x Tinman's shears
- 1 x Trimming knife
- 1 x Trimming knife blades
- 1 x Waterpump plier

Draper Tools reserves the right to substitute items in the kit of equivalent finish or quality if the original item quoted in the above list has been discontinued or is out of stock.

Stock No.	Part No.
98886	DTKDTK2019B





1 40" Mechanic's MegaKit

A super tough, powder coated 8 drawer tool chest and 11 drawer roller cabinet. Packed with 700 tool pieces, stored in high quality EVA foam trays. Included with the MegaKit is a slimline COB LED inspection lamp.

Contents:

- | | |
|---|--|
| 1 x Full Drawer EVA Insert Infill Tray (3 Piece) | Converter Set (16 Piece) |
| 1 x Soft Grip Screwdriver Set (27 Piece) | 1 x Precision Bar Set (5 Piece) |
| 1 x Spanner Set (28 Piece), Plier Set (11 Piece) | 1 x VDE Ergo Plus Screwdriver Set (10 Piece) |
| 1 x 1/4", 3/8", 1/2" Socket Set (96 Piece) | 1 x Screwdriver Impact Bits and Driver Set (40 Piece) |
| 1 x File Set (2 Piece) | 1 x Combination Tap and Die Set (22 Piece) |
| 1 x Plier Set (2 Piece) | 1 x 1/4 Drawer EVA Infill Tray (3 Piece) |
| 1 x Punch and Impact Driver Kit (25 Piece) | 1 x VDE Approved Plier Set (4 Piece) |
| 1 x Bit Set (196 Piece) | 1 x VDE Approved Screwdriver Set (11 Piece) |
| 1 x Caliper Windback Kit (18 Piece) | 1 x Tool Kit (36 Pieces) |
| 1 x Scraper, Hook and Pick Set (9 Piece) | 1 x 'T' Handle Ball End Hexagon Key Set (7 Piece) |
| 1 x 1/2" Sq. Dr. Deep Impact Socket Set (11 Piece) | 1 x 'T' Handle Ball End TX-STAR® Key Set (7 Piece) |
| 1 x 1/2" Sq. Dr. Impact Socket Set (15 Piece) | 1 x 6-24V Automotive Circuit Tester |
| 1 x 1/2" Sq. Dr. Impact Socket Set and Extension Bar Set (16 Piece) | 1 x Automotive Automatic and Manual Ranging Digital Multimeter |
| 1 x 1/2" Sq. Dr. Impact TX-STAR® and Hex Socket Set (28 Piece) | 1 x 1.8kg Fibreglass Shaft Club Hammer |
| 1 x Oil Service Kit (101 Pieces) | 1 x 1kg Deadblow Hammer |
| 1 x Extension Bar | |
| 1 x Universal Joints and Socket | |

Stock No.	Part No.
98887	DTKMEGA2019 40"





1
26" Mechanic's MegaKit

A super tough, powder-coated 10 drawer tool chest and 9 drawer roller cabinet. Packed with 700 tool pieces, stored in high-quality EVA foam trays. Included with the MegaKit is a slimline COB LED inspection lamp.

Contents:

- | | |
|---|--|
| 1 x Full Drawer EVA Insert Infill Tray (3 Piece) | 1 x Universal Joints and Socket Converter Set (16 Piece) |
| 1 x Soft Grip Screwdriver Set (27 Piece) | 1 x Precision Bar Set (5 Piece) |
| 1 x Spanner Set (28 Piece) | 1 x VDE Ergo Plus Screwdriver Set (10 Piece) |
| 1 x Plier Set (11 Piece) | 1 x Screwdriver Impact Bits and Driver Set (40 Piece) |
| 1 x 1/4", 3/8", 1/2" Socket Set (96 Piece) | 1 x Combination Tap and Die Set (22 Piece) |
| 1 x File Set (2 Piece) | 1 x 1/4" Drawer EVA Infill Tray (3 Piece) |
| 1 x Plier Set (2 Piece) | 1 x VDE Approved Plier Set (4 Piece) |
| 1 x Punch and Impact Driver Kit (25 Piece) | 1 x VDE Approved Screwdriver Set (11 Piece) |
| 1 x Bit Set (196 Piece) | 1 x Tool Kit (36 Pieces) |
| 1 x Caliper Windback Kit (18 Piece) | 1 x 'T' Handle Ball End Hexagon Key Set (7 Piece) |
| 1 x Scraper | 1 x 'T' Handle Ball End TX-STAR® Key Set (7 Piece) |
| 1 x Hook and Pick Set (9 Piece) | 1 x 6 - 24V Automotive Circuit Tester |
| 1 x 1/2" Sq. Dr. Deep Impact Socket Set (11 Piece) | 1 x Automotive Automatic and Manual Ranging Digital Multimeter |
| 1 x 1/2" Sq. Dr. Impact Socket Set (15 Piece) | 1 x 1.8kg Fibreglass Shaft Club Hammer |
| 1 x 1/2" Sq. Dr. Impact Socket Set and Extension Bar Set (16 Piece) | 1 x 1kg Deadblow Hammer |
| 1 x 1/2" Sq. Dr. Impact TX-STAR® and Hex Socket Set (28 Piece) | |
| 1 x Oil Service Kit (101 Pieces) | |
| 1 x Extension Bar | |

Stock No.	Part No.
98888	DTKMEGA2019 26"





1

Tool Kit in Steel Cantilever Toolbox (126 Piece)

Vast selection of commonly used tools for the workshop and around the home contained inside a steel cantilever toolbox. Featuring a 45-tooth reversible ratchet, 16oz claw hammer, combination pliers, side cutters, a range of screwdrivers, a tape measure and a wide selection of screwdriver bits, sockets and hex keys. Lining the toolbox are high density foam inserts to help organise storage and clearly spot when tools are missing. Cantilever toolbox manufactured from sheet steel with five trays and measuring 420 x 200 x 200mm.

Contents:

- | | |
|--|--|
| 1 x 3/8" Ratchet wrench | 1 x 1/4" Hex x 1/4" Square drive adaptor |
| 1 x 75mm 3/8" Square drive extension bar | 8 x Metric hex keys: 1.5, 2, 2.5, 3, 4, 5, 5.5 and 6mm |
| 2 x Spark plug sockets 16mm and 21mm | 8 x Imperial hex keys: 1/16, 5/64, 3/32, 1/8, 5/32, 3/16, 7/32, and 1/4" |
| 1 x 3/8 (F) x 1/4" (M) Adaptor | 1 x 16oz BS876 Claw hammer |
| 10 x 3/8" Sockets: 9, 10, 11, 12, 13, 14, 15, 16, 17 and 19mm | 1 x 5m Tape measure |
| 8 x 3/8" Sockets: 5/16, 3/8, 7/16, 1/2, 9/16, 5/8, 11/16, and 3/4" | 1 x 150mm Combination pliers |
| 10 x 1/4" Sockets: 4, 5, 6, 7, 8, 9, 10, 11, 12 and 13mm | 1 x 150mm Side cutters |
| 10 x 1/4" Sockets: 5/32, 3/16, 7/32, 1/4, 9/32, 5/16, 11/32, 3/8, 7/16, and 1/2" | 4 x Screwdrivers: |
| 3 x 1/4" E Sockets: E6, E7 and E8 | 2 x Plain slot - 5x75mm and 6x100mm |
| 1 x 1/4" Screwdriver bit driver | 2 x Cross slot - PH1 x 75mm and PH2x100mm |
| 1 x 1/4" Hex bit holder (60mm) | 6 x Combination spanners: 8, 10, 12, 13, 14 and 17mm |
| 19 x 1/4" Hex 25mm CRV screwdriver bits: PH0, PH1, PH2, PH3, PZ1, PZ2, PZ3, H3, H4, H5, H6, SL4, T8, T10, T15, T20, T25, T27 and T30 | 1 x 18mm Utility knife |
| | 1 x Scissors |
| | 25 x 150mm Cable ties |
| | 1 x Cantilever tool box |



Stock No.	Part No.
48091	TK126



1
Tool Kit (138 Piece)

Vast selection of commonly used hand tools ideal for the workshop and around the home presented inside a storage case. Featuring a 3/8" square drive 72 tooth reversible ratchet, 8oz claw hammer, water pump pliers, mini hacksaw, a utility knife with retractable blades, boat level and a wide selection of screwdrivers, screwdriver bits, hex keys, spanners and sockets. All of the tools are supplied inside a sturdy blow moulded plastic storage case.

Contents:

- 12 x 1/4" Draper Expert HI-TORQ® six-point sockets: 4, 4.5, 5, 5.5, 6, 7, 8, 9, 10, 11, 12 and 13mm
- 11 x 1/2" Draper Expert HI-TORQ® six-point sockets: 13, 14, 15, 16, 17, 18, 19, 21, 22, 24 and 27mm
- 2 x Plain slot screwdrivers: 5x75mm and 6x100mm
- 2 x PH-Type screwdrivers: PH1x75 and PH2x100mm
- 21 x 25mm CRV Screwdriver bits: SL4, SL5, SL5.5, SL6.5, PH1, PH2, PH3, H3, H4, H5, H6, S1, S2, S3 (square), T10, T20, T25, T30, PZ1, PZ2 and PZ3
- 1 x 177mm Combination pliers
- 1 x 150mm Long nose pliers
- 1 x 250mm Adjustable wrench
- 1 x 1/4" Bit driver
- 1 x 3/8" (F) x 1/4" (M)
- 1 x 1/4" Sq. drive 72 tooth reversible ratchet
- 1 x 19mm Cold chisel
- 1 x 3mm Centre punch
- 2 x Pin punch: 2 and 4mm
- 1 x 250mm Mini handy saw
- 1 x 250mm Blade for mini handy saw
- 1 x 142mm Scissors
- 1 x 5m Measuring tape
- 1 x 1/2" x 125mm Extension bar
- 2 x 1/2" Sq. drive spark plug sockets 10 and 14mm
- 1 x 3/8" (F) x 1/2" (M)
- 1 x 1/4" x 75mm Extension bar
- 11 x Combination spanners: 8, 9, 10, 11, 12, 13, 14, 16, 17, 18 and 19mm
- 1 x 200mm Flat file
- 1 x 18mm Knife
- 1 x 16oz Claw hammer
- 1 x 1/2" Sq. drive 72 tooth reversible ratchet
- 1 x 1/4" Sq. drive x 1/4" hex. bit adaptor
- 5 x 1/4" E sockets: E4, E5, E6, E7 and E8
- 1 x 1/4" Sq. drive x 3/8" Sq. drive adaptor

Stock No.	Part No.
94988	TK138



1 Tool Kit (100 Piece)

Comprehensive range of commonly used hand tools for the workshop and around the home. The sockets and many of the hand tools featured are manufactured from chrome vanadium steel, correctly hardened and tempered. The tool kit includes 1/2" and 1/4" square drive 72-tooth reversible ratchets, self-grip pliers, extension bars and a wide range of spanners, screwdrivers, screwdriver bits and square drive sockets. All the tools are organised inside a sturdy blow moulded plastic storage box.

Contents:

- | | |
|--|--|
| 11 x 1/4" Sq. drive sockets: 4, 4.5, 5, 5.5, 6, 7, 8, 9, 10, 11 and 12mm | 1 x 1/2" Sq. drive 72 tooth reversible ratchet |
| 14 x 1/2" Sq. drive sockets: 10, 11, 12, 13, 14, 15, 16, 17, 18, 19, 20, 21, 22 and 24mm | 1 x 250mm Water pump pliers |
| 5 x Screwdrivers: | 1 x 1/2" x 125mm Extension bar |
| 3 x plain slot – 5 x 75mm, 6 x 100mm and 8 x 150mm | 1 x 1/4" x 75mm Extension bar |
| 2 x cross slot – PH1 x 75mm and PH2 x 100mm | 1 x 1/2" x 250mm Extension bar |
| 20 x 1/4" Hex 25mm CRV screwdriver bits: PH0, PH1, PH2, PH3, PZ1, PZ2, PZ3, H3, H4, H5, H6, SL4, T8, T10, T15, T20, T25, T27, T30 and 1/4" Sq. drive adaptor | 1 x 150mm Long nose pliers |
| 13 x Spanners: 6, 7, 8, 9, 10, 11, 12, 13, 14, 15, 16, 17 and 19mm | 1 x 150mm Side cutters |
| 1 x 18mm Utility knife | 1 x 1/2" Universal joint |
| 10 x Retractable trimming knife blades | 1 x 3/8" (F) x 1/2" (M) Sq. driver sliding extension bar adaptor |
| 1 x 1/4" Sq. drive spinner handle | 1 x 3m Measuring tape |
| | 2 x Spark plug sockets: 10 and 14mm |
| | 1 x 250mm Self-grip pliers |
| | 1 x 1/4" Sq. drive x 1/4" Hex. adaptor |
| | 1 x 1/4" Sq. drive 72 tooth reversible ratchet |
| | 10 x Hex keys: 1.5, 2, 2.5, 3, 4, 5, 6, 7, 8 and 10mm |

Stock No.	Part No.
08627	TK100

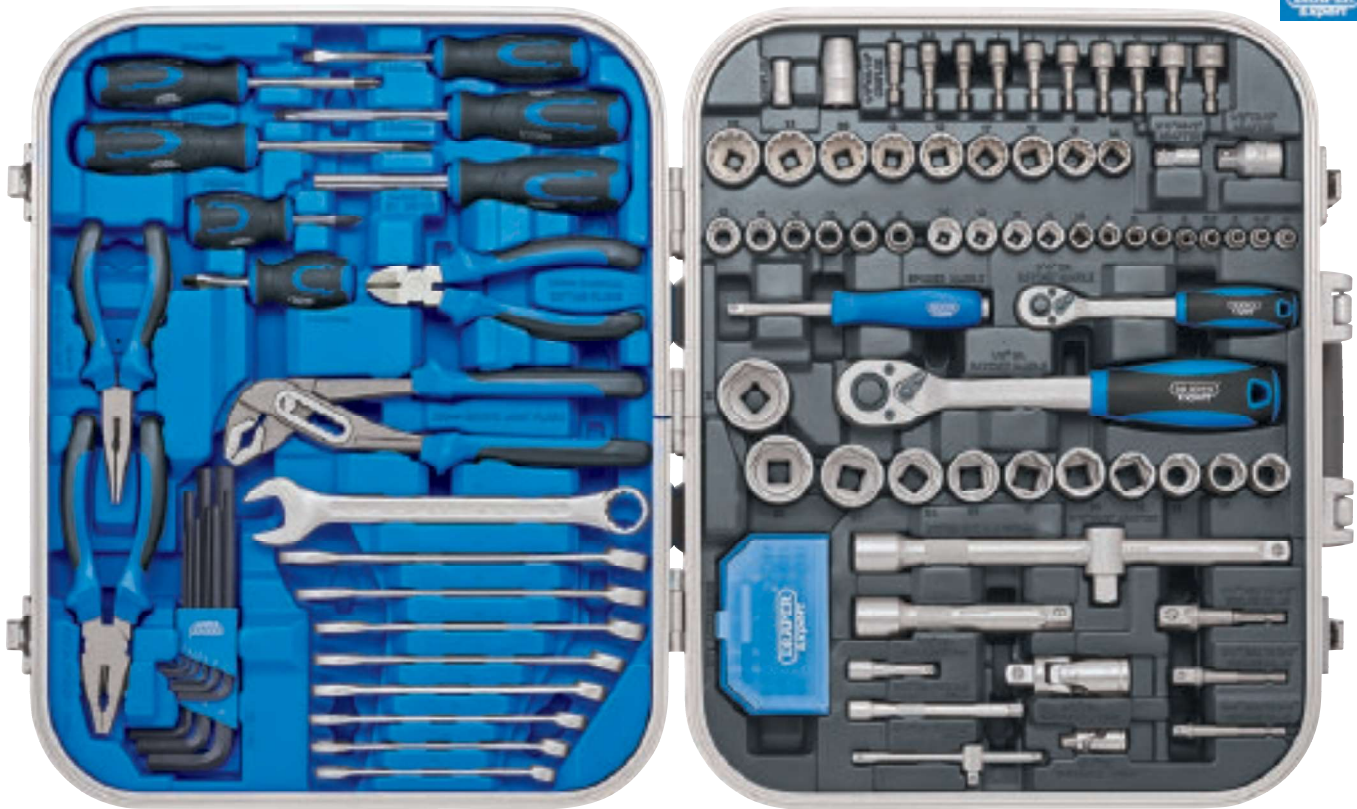

1
Draper Expert Mechanic's Tool Kit (127 Piece)

This premium-quality kit includes a vast selection of commonly used tools for the workshop, mobile engineer and mechanic. Manufactured from high quality chrome vanadium steel, correctly hardened and tempered. Featuring many hand tools including 1/4" and 1/2" Sq. Drive 72-tooth reversible ratchets with soft grip handles, plain slot and PH type screwdrivers, combination spanners, spinner handle, side cutters, combination pliers, long nose pliers and more. Plus, a wide range of Draper HI-TORQ® and MULTI-DRIVE® sockets and spanners. Organised inside a heavy-duty reinforced lockable case with aluminium trim and handle, supplied with two keys. The convenience of this comprehensive kit and extra security is ideal for a mobile engineer or mechanic who is fixing and servicing vehicles on the move.

Contents:

- 9 x Combination spanners: 10, 11, 12, 13, 14, 15, 16, 17 and 19mm
- 9 x Long arm hex key set: 1.5, 2, 2.5, 3, 4, 5, 6, 8 and 10
- 1 x Magnetic tip bit driver
- 3 x Plain slot screwdriver: 6.5 x 38mm, 5.5 x 75mm and 6.5 x 100mm
- 3 x PH type screwdriver: PH2 x 38mm, PH1 x 75mm and PH2 x 100mm
- 1 x 150mm Long nose plier
- 1 x 170mm Combination plier
- 1 x 150mm Diagonal side cutter
- 1 x 250mm Water pump plier
- 1 x 1/2" Square drive reversible ratchet
- 1 x 1/4" Square drive reversible ratchet
- 13 x 1/4" Square drive 6-point sockets: 4, 4.5, 5, 5.5, 6, 7, 8, 9, 10, 11, 12, 13 and 14mm
- 15 x 3/8" Square drive multi-drive sockets: 8, 9, 10, 11, 12, 13, 14, 15, 16, 17, 18, 19, 20, 21 and 22mm
- 11 x 1/2" Square drive 6-point sockets: 15, 16, 17, 19, 20, 21, 22, 24, 27, 30 and 32mm
- 10 x Nut drivers: 5, 5.5, 6, 7, 8, 9, 10, 11, 12 and 13mm
- 1 x 1/4" Square drive coupler
- 1 x 1/4" Quick release 1/4" Hex driver
- 1 x Socket adapter 1/4" (F) x 3/8" (M)
- 1 x 1/4" Hex to 1/4" Square drive adapter
- 1 x 1/4" Hex to 3/8" Square drive adapter
- 1 x 1/4" Hex to 1/2" Square drive adapter
- 1 x 1/4" Square drive spinner handle
- 2 x 1/4" Square drive extension bar - 50mm and 100mm
- 2 x 1/2" Square drive extension bar - 125mm and 250mm
- 1 x 1/4" Square drive sliding T-bar
- 1 x 1/2" (M) x 3/8" (F) 3 Way socket adapter
- 1 x 1/4" Square drive universal joint
- 1 x 1/2" Square drive universal joint
- 30 x 25mm Screwdriver bits in plastic case:
 - TX-STAR® - T10 x 2, T15 x 2, T20 x 2, T25, T27, T30 and T40
 - PH Type - PH0 x 2, PH1 x 2, PH2 x 4 and PH x 2
 - Slotted - 3, 4, 5, 5.5 and 6mm
 - Hex - 3, 4, 5, 5.5 and 6mm
 - 1 x Square drive socket adapter 1/2" (F) x 3/8" (M)
 - 1 x 1/2" x 5/16" Coupler

Stock No.	Part No.
32027	TK127



1 Tool Kit (90 Piece)

This premium quality kit includes a vast selection of commonly used tools for the workshop, garage and around the home arranged inside a steel cantilever toolbox. Featuring two 72-tooth reversible ratchets, 16oz claw hammer, combination pliers, long nose pliers, a range of screwdrivers, a tape measure and a wide selection of combination spanners, screwdriver bits, sockets. Lining the toolbox are high density foam inserts to help organise storage and clearly spot when tools are missing. Cantilever toolbox manufactured from sheet steel with five trays and measuring 480 x 230 x 230mm.

Contents:

- | | |
|--|---|
| 12 x 1/4" Draper Expert HI-TORQ® six-point sockets:
4, 4.5, 5, 5.5, 6, 7, 8, 9, 10, 11, 12 and 13mm | 1 x 250mm Mini handy saw |
| 11 x 1/2" Draper Expert HI-TORQ® six-point sockets:
13, 14, 15, 16, 17, 18, 19, 21, 22, 24 and 27mm | 1 x 250mm Blade for mini handy saw |
| 2 x Plain slot screwdrivers: 5 x 75mm and 6 x 100mm | 1 x 142mm Scissors |
| 2 x PH-Type screwdrivers: PH1 x 75 and
PH2 x 100mm | 1 x 5m Measuring tape |
| 21 x 25mm CRV Screwdriver bits: SL4, SL5, SL5.5,
SL6.5, PH1, PH2, PH3, H3, H4, H5, H6, S1, S2, S3
(square), T10, T20, T25, T30, PZ1, PZ2 and PZ3 | 1 x 1/2" x 125mm Extension bar |
| 1 x 177mm Combination pliers | 2 x 1/2" Sq. drive spark plug sockets 10 and 14mm |
| 1 x 150mm Long nose pliers | 1 x 3/8" (F) x 1/2" (M) |
| 1 x 250mm Adjustable wrench | 1 x 1/4" x 75mm Extension bar |
| 1 x 1/4" Bit driver | 11 x Combination spanners: 8, 9, 10, 11, 12, 13, 14,
16, 17, 18 and 19mm |
| 1 x 3/8" (F) x 1/4" (M) | 1 x 200mm Flat file |
| 1 x 1/4" Sq. drive 72 tooth reversible ratchet | 1 x 18mm Knife |
| 1 x 19mm Cold chisel | 1 x 16oz Claw hammer |
| 1 x 3mm Centre punch | 1 x 1/2" Sq. drive 72 tooth reversible ratchet |
| 2 x Pin punch: 2 and 4mm | 1 x 1/4" Sq. drive x 1/4" hex. bit adaptor |
| | 5 x 1/4" E sockets: E4, E5, E6, E7 and E8 |
| | 1 x 1/4" Sq. drive x 3/8" Sq. drive adaptor |
| | 1 x Cantilever toolbox |

Stock No.	Part No.
70282	TK90

